

STR-D390/D590

SERVICE MANUAL

US Model
Canadian Model
UK Model
STR-D390/D590
E Model
STR-D390



Photo : STR-D590

SPECIFICATIONS

Audio Power Specifications

POWER OUTPUT AND TOTAL HARMONIC DISTORTION

With 8-ohm load, both channels driven, from 40 - 20,000 Hz, rated 60(STR-D590)/40(STR-D390) watts per channel minimum RMS power, with less than 0.8% total harmonic distortion from 250 milliwatts to rated output.

Other Specifications

Amplifier section

Continuous RMS power output (8 ohms, at 1kHz less than 0.8% total harmonic distortion)

70W+70W(STR-D590 : US/Canadian model)

60W+60W(STR-D590 : UK model)

50W+50W(STR-D390)

Dynamic power (at 1 kHz IHF)

75W+75W(8 ohms)(STR-D590 : US/Canadian model)

65W+65W(8 ohms)(STR-D590 : UK model)

55W+55W(8 ohms)(STR-D390)

80W+80W(4 ohms)(STR-D590 : US/Canadian model)

50W+50W(4 ohms)(STR-D390)

Harmonic distortion

Less than 0.8% at rated output

Power output of surround amplifier (4 ohms, at 1 kHz less than 0.8% total harmonic distortion)

10W

Frequency response

PHONO : RIAA equalization curve ± 0.5 dB

CD

VIDEO] 10 Hz - 50 kHz ± 0 dB

TAPE]

Inputs

	Sensitivity	Impedance	S/N (weighting network, input level)
PHONO	2.5 mV	50 kilohms	74 dB 72 dB* (A, 2.5 mV)
CD / VIDEO 1, 2 / TAPE (STR-D590)	150 mV	50 kilohms	95 dB 80 dB* (A, 150 mV)
CD / VIDEO / TAPE 1, 2 (STR-D390)	200 mV		

* 78 IHF

Outputs

REC OUT, VIDEO 1 (AUDIO) OUT	Voltage : 150 mV (STR-D590) : 200 mV (STR-D390) Impedance 10 kilohms
SPEAKER A, B	Accepts speakers of 8-16 ohms
HEADPHONES	Accepts low and high impedance headphones

Tone controls

BASS : ± 10 dB at 100 Hz

TREBLE : ± 10 dB at 10 kHz

Muting (STR-D590)

-20 dB

DBFB (STR-D590)

+10 dB at 70 Hz

Variable loudness control (STR-D390)

+6 dB at 100 Hz (MAX)

— Continued on next page —

FM STEREO/FM-AM RECEIVER
SONY[®]

Video section (STR-D590)

INPUT	VIDEO 1, 2	1 Vp-p 75 ohms
OUTPUT	VIDEO 1 MONITOR	1 Vp-p 75 ohms

Tuner section

	FM tuner section	AM tuner section
Tuning range	87.5—108 MHz	530—1710 kHz (10 kHz step) 531—1710 kHz (9 kHz step) 530—1710 kHz (10 kHz step) 531—1602 kHz (9 kHz step) 531—1602 kHz (UK model)
Antenna terminals	300 ohms, balanced 75 ohms, unbalanced	External antenna terminal
Sensitivity at 50 dB quieting	18.3 dBf, 4.5 μ V (mono) (STR-D590 : US/Canadian model, STR-D390 except UK model) 18.3 dBf, 2.25 μ V, 75 ohms (mono)(UK model) 38.3 dBf, 45 μ V (stereo) (STR-D590 : US/Canadian model, STR-D390 except UK model) 38.3 dBf, 22.5 μ V, 75 ohms (stereo)(UK model)	
Usable sensitivity	11.2 dBf, 2 μ V (IHF) (STR-D590 : US/Canadian model, STR-D390 except UK model) 11.2 dBf, 1 μ V (IHF) (UK model)	Loop antenna : 500 μ V (at 1,000 kHz)
Signal-to-noise ratio	76 dB (mono) (STR-D590 : US/Canadian model, STR-D390 except UK model) 70 dB (mono)(UK model) 70 dB (stereo) (STR-D590 : US/Canadian model, STR-D390 except UK model) 66 dB (stereo)(UK model)	54 dB (at 50 mV/m)
Harmonic distortion	0.3% (mono), 0.5%(stereo) at 1 kHz	0.5% (at 50mV/m, 400 Hz)
Selectivity	60 dB at 400 kHz	40 dB at 10 kHz (STR-D590 : US/Canadian model, STR-D390) 30 dB at 9 kHz (STR-D590 : UK model)
Separation	45 dB at 1 kHz	
Frequency response	30 Hz—15 kHz $^{+0.5}_{-2}$ dB	

General

System

Tuner section : PLL quartz-locked digital synthesizer system

Preamplifier section : low-noise NF type equalizer amp

Power amplifier section : pure complementary SEPP

Power requirements

120V AC, 60 Hz (STR-D590 : US/Canadian model,
STR-D390 : US/Canadian model)

240V AC, 50 Hz (UK model)

220V AC, 50 Hz or 120V, 240V AC, adjustable, 50/60 Hz
(E model)

Power consumption

140 W (STR-D590 : US model)

150 W (STR-D590 : Canadian model)

110 W (STR-D390 : Canadian model)

100 W (STR-D390 : E model)

5W : In standby condition

AC outlet

One switched

120 W/1A Max. (STR-D590 : US/Canadian model,
STR-D390 : US/Canadian model)

100 W/1A Max. (UK, E model)

Dimensions

Approx. 430×135×300 mm (w/h/d)

(17×5 $\frac{3}{8}$ ×11 $\frac{7}{8}$ inches)

including projecting parts and controls

Weight

Approx. 6.3 kg (13 lb 15 oz)

(STR-D390 : UK model)

Approx. 6.5 kg (14 lb 6 oz)

(STR-D590, STR-D390 : US/E model)

Approx. 5.7 kg (12 lb 10 oz)

(STR-D390 : Canadian model)

Accessories supplied

FM wire antenna (1)

AM loop antenna (1)

Remote Commander

RM-U222 (1) (STR-D590)

RM-U223 (1) (STR-D390 : Canadian model)

RM-S103 (1) (STR-D390 : US, UK, E model)

Sony batteries SUM-3 (NS) (2)

Design and specifications are subject to change without notice.

TABLE OF CONTENTS

<u>Section</u>	<u>Title</u>	<u>Page</u>
SECTION 1. GENERAL	4
SECTION 2. IC PIN ASSIGNMENT	5
SECTION 3. ELECTRICAL ADJUSTMENTS	9
SECTION 4. DIAGRAMS		
4-1.	Printed Wiring Board — Main Section —	11
4-2.	Schematic Diagram — Main Section —	15
	IC Block Diagrams.....	15
4-3.	Printed Wiring Board — Display Section —	19
4-4.	Schematic Diagram — Display Section —	23
	IC Block Diagrams.....	25
4-5.	Schematic Diagram — Tuner Section —	26
	IC Block Diagrams.....	28
4-6.	Circuit Boards Location	29
4-7.	Semiconductor Lead Layouts	30
SECTION 5. EXPLODED VIEWS		
5-1.	Front Panel Section	32
5-2.	Chassis Section	33
SECTION 6. ELECTRICAL PARTS LIST	34

SAFETY CHECK-OUT

After correcting the original service problem, perform the following safety check before releasing the set to the customer:

Check the antenna terminals, metal trim, "metallized" knobs, screws, and all other exposed metal parts for AC leakage. Check leakage as described below.

LEAKAGE TEST

The AC leakage from any exposed metal part to earth ground and from all exposed metal parts to any exposed metal part having a return to chassis, must not exceed 0.5 mA (500 microamperes). Leakage current can be measured by any one of three methods.

1. A commercial leakage tester, such as the Simpson 229 or RCA WT-540A. Follow the manufacturers' instructions to use these instruments.
2. A battery-operated AC milliammeter. The Data Precision 245 digital multimeter is suitable for this job.
3. Measuring the voltage drop across a resistor by means of a VOM or battery-operated AC voltmeter. The "limit" indication is 0.75 V, so analog meters must have an accurate low-voltage scale. The Simpson 250 and Sanwa SH-63Trd are examples of a passive VOM that is suitable. Nearly all battery operated digital multimeters that have a 2 V AC range are suitable. (See Fig. A)

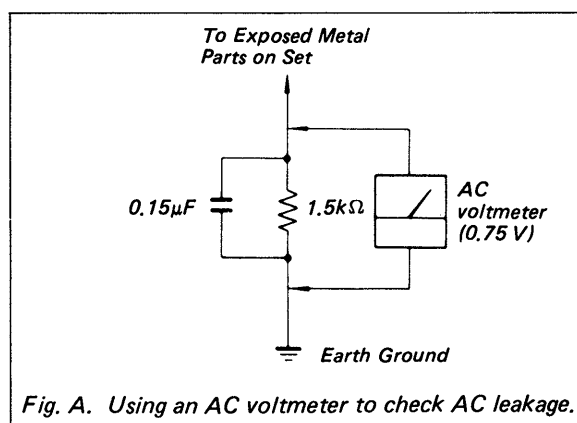
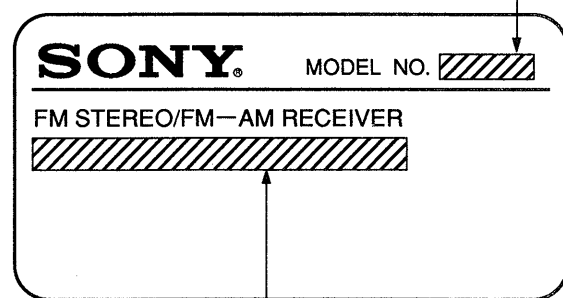

Fig. A. Using an AC voltmeter to check AC leakage.

MODEL IDENTIFICATION

— Model Number Portion —

STR-D390
STR-D590





US, Canadian model: AC 120V 60Hz

UK model: AC 240V 50Hz

E model: AC 110-120V/220-240V 50/60Hz

SAFETY-RELATED COMPONENT WARNING!!

COMPONENTS IDENTIFIED BY MARK  OR DOTTED LINE WITH MARK  ON THE SCHEMATIC DIAGRAMS AND IN THE PARTS LIST ARE CRITICAL TO SAFE OPERATION. REPLACE THESE COMPONENTS WITH SONY PARTS WHOSE PART NUMBERS APPEAR AS SHOWN IN THIS MANUAL OR IN SUPPLEMENTS PUBLISHED BY SONY.

ATTENTION AU COMPOSANT AYANT RAPPORT À LA SÉCURITÉ!

LES COMPOSANTS IDENTIFIÉS PAR UNE MARQUE  SUR LES DIAGRAMMES SCHÉMATIQUES ET LA LISTE DES PIÈCES SONT CRITIQUES POUR LA SÉCURITÉ DE FONCTIONNEMENT. NE REMPLACER CES COMPOSANTS QUE PAR DES PIÈCES SONY DONT LES NUMÉROS SONT DONNÉS DANS CE MANUEL OU DANS LES SUPPLÉMENTS PUBLIÉS PAR SONY.

SECTION 1 GENERAL

This section is extracted
from instruction manual.

Parts Identification

Front Panel

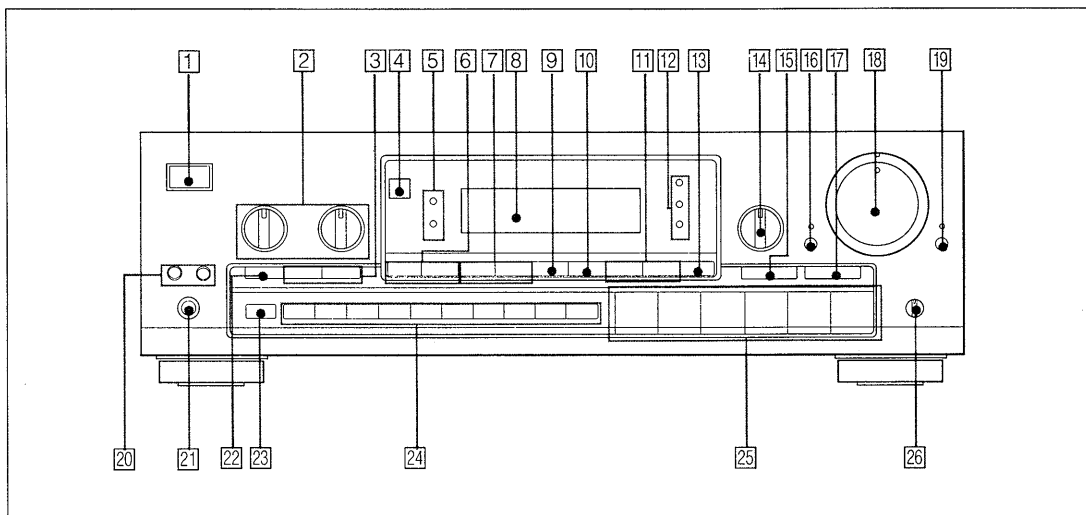

- | | |
|--|--|
| 1 POWER switch | 15 SURROUND MODE selector (STR-D590) |
| 2 BASS/TREBLE TONE controls | 16 MUTING switch and indicator (STR-D590) |
| 3 REAR LEVEL +/- buttons (STR-D590) | 17 SOUND FIELD ON/OFF button (STR-D590) |
| 4 Remote control sensor | 18 MASTER VOLUME control |
| 5 VIDEO 1/2 indicators (STR-D590) | 19 DBFB (Dynamic Bass Feed Back) button and indicator (STR-D590) |
| 6 TUNING +/- buttons | 20 SPEAKERS A/B buttons |
| 7 PRESET TUNING +/- buttons | 21 HEADPHONES jack |
| 8 Display window | 22 DELAY TIME (S, M, L) selector (STR-D590) |
| 9 MEMORY button | 23 SHIFT button |
| 10 FM MODE button | 24 Numeric buttons |
| 11 FM/AM BAND selectors | 25 Function selectors |
| 12 SURROUND MODE indicators (STR-D590)
MONITOR indicator (STR-D390) | 26 INPUT BALANCE control (STR-D590)
LOUDNESS control (STR-D390) |
| 13 TUNING DIRECT button | |
| 14 BALANCE control | |

SECTION 2

IC PIN ASSIGNMENT

• μ PD75206GF-726-3BE (1/2)

PIN No.	SIGNAL NAME	FUNCTION	I/O
1	RESET	Micro Computer RESET	I
2	T0	FL tube indication (invalid) digit	0
3	T1	FL tube indication digit	0
4	T2	FL tube indication digit	0
5	T3	FL tube indication digit	0
6	T4	FL tube indication digit	0
7	T5	FL tube indication digit	0
8	T6	FL tube indication digit	0
9	T7	FL tube indication digit	0
10	T8	FL tube indication digit	0
11	T9	FL tube signal indication digit	0
12	T10/PH3	SURR. C/MONITOR OUTPUT	0
13	T11/PH2	SURR. B OUTPUT	0
14	T12/PH1	SURR. A OUTPUT	0
15	T13/PH0	-20dB Muting Output	0
16	T14/S11	FL tube indication Segment/Diode	0
17	T15/S10	FL tube indication Segment/Diode	0
18	V road	FL tube pulldown power supply	-
19	V pre	FL tube driver power supply	-
20	S9	FL tube indication Segment/Diode	0
21	S8	FL tube indication Segment/Key Scan	0
22	S7	FL tube indication Segment/Key Scan	0
23	S6	FL tube indication Segment/Key Scan	0
24	S5	FL tube indication Segment/Key Scan	0
25	S4	FL tube indication Segment/Key Scan	0
26	V _{DD}	Micro Computer power supply	-
27	S3	FL tube indication Segment/Key Scan	0
28	S2	FL tube indication Segment/Key Scan	0
29	S1	FL tube indication Segment/Key Scan	0
30	S0	FL tube indication Segment/Key Scan	0
31	P00/INT4	Signal to cut power supply	I
32	P01/SCK	Serial latch for electrical adjustment use	I

PIN No.	SIGNAL NAME	FUNCTION	I/O
33	P02/S0	Tuner Auto Stop input	I
34	P03/S1	Tuner Stereo input	I
35	P10/INT0	Remote Control Signal input	I
36	P11/INT1	Protector input	I
37	P12/INT2	System Power Key input	I
38	P13/T10	IF Data input	I
39	P20	DBFB output	O
40	P21	Video Control A	O
41	P22	Video Control B	O
42	P23/BUZ	Video Control C	O
43	P30	Protector Muting	O
44	P31	SURR. RY	O
45	P32	Standby LED Output	O
46	P33	Tuner Muting	O
47	P60	PLL/7822 Latch	O
48	P61	PLL/7822/SI Data	I/O
49	P62	PLL/7822/SI Clock	I/O
50	P63	LV1001 latch	O
51	P40	Function Muting	O
52	P41	Motor Volume UP	O
53	P42	Motor Volume DOWN	O
54	P43	Speaker Relay	O
55	PP0	Power Relay	O
56	X1	Ceramic Oscillator	-
57	X2	Ceramic Oscillator	-
58	V _{ss}	Micro Computer GND	-
59	XT1	—	-
60	XT2	—	-
61	P50	Key Scan input	I
62	P51	Key Scan input	I
63	P52	Key Scan input	I
64	P53	Key Scan input	I

• LV1001M (1/2)

PIN No.	FUNCTION
1	De-couple capacitor for threshold voltage
2	Capacitor for smoothing of rectifier output
3	Capacitor for sliding band filter and Delayed output
4	Capacitor for sliding band filter
5	Capacitor for pre-emphasis
6	Input filter for rectifier
7	Input filter for rectifier
8	Reference voltage-1
9	Reference voltage-2
10	Mute control
11	Vcc
12	Output for V _{DD}
13	Clock input for serial input, data input for parallel input mode
14	Data input for serial input, data input for parallel input mode
15	Column address selection for serial input, data input for parallel input mode
16	Row address selection for serial input, data input for parallel input mode
17	V _{DD}
18	Connection to memory device (A7)
19	Connection to memory device (A5)
20	Connection to memory device (A4)
21	Connection to memory device (A3)
22	Connection to memory device (A6)
23	Connection to memory device (DIN)
24	Connection to memory device (*CAS)
25	V _{SS}
26	Connection to memory device (AB)
27	Connection to memory device (DOUT)
28	Connection to memory device (*WE)
29	Connection to memory device (*RAS)
30	Connection to memory device (A0)
31	Connection to memory device (A2)
32	Connection to memory device (A1)

PIN No.	FUNCTION
33	X'tal resonator for oscillator
34	X'tal resonator for oscillator
35	Long or Short mode selection
36	Serial or Parallel mode selection
37	For rest mode
38	Smoothing for NR rectifier
39	Smoothing for NR rectifier
40	Capacitor for weighting on side chain path
41	Input for Variable resistor
42	NR output
43	7kHz low pass filter output
44	Input for NR
45	Capacitor for de-couple on NR
46	Delay output or NR output
47	Input for mute circuit
48	Output for mute circuit
49	Output for 7kHz low pass filter
50	Input for 7kHz low pass filter
51	GND
52	Input for right channel
53	Input for left channel
54	Capacitor for de-couple on Fixed matrix output
55	Noise shaping and delay input
56	Noise shaping output
57	Delay input signal mode select switch (L+R/L-R)
58	Filter for supply voltage on comparator
59	Input filter for rectifier
60	Input filter for rectifier
61	Capacitor for pre-emphasis
62	Capacitor for sliding band filter
63	Capacitor for sliding band filter and local decoder output
64	Capacitor for smoothing of rectifier output

SECTION 3 ELECTRICAL ADJUSTMENTS

FM SECTION

• FM Discriminator (NULL) Adjustment

Setting :

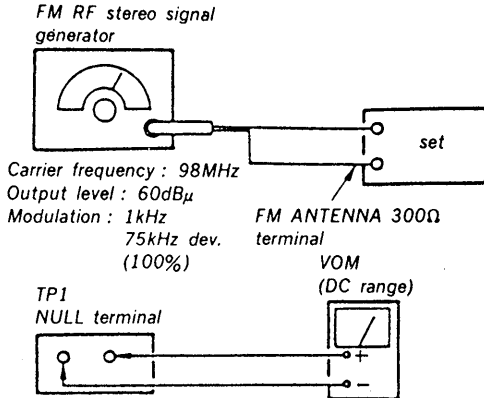

Procedure :

1. Tune the set to 98MHz.
2. Adjust T21 for 0V reading on the VOM.

Note : FM Tuning Level adjustment should be made after FM discriminator adjustment.

• FM Stereo Operation Level Adjustment

Setting :

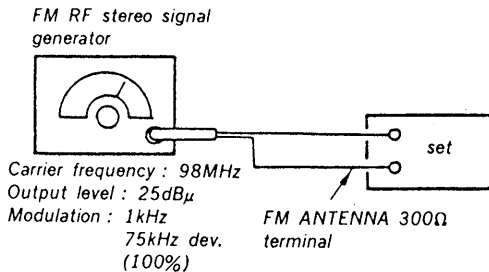

Procedure :

1. Tune the set to 98MHz.
2. Adjust RV24 so that the STEREO LED goes on.

• FM Stereo Separation Adjustment

Setting :

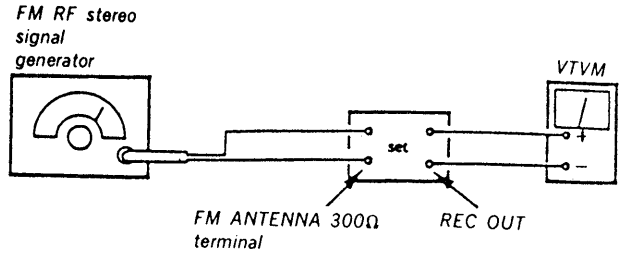

Carrier frequency : 98MHz
Output level : 60dB μ
Modulation :
Audio (1kHz) : 33.75kHz dev. (45%)
Pilot (19kHz) : 7.5kHz dev. (10%)
Sub-channel (38kHz) : 33.75kHz dev. (45%)

Procedure :

Tune the set to 98MHz.

FM stereo signal generator output channel	VTVM connection	VTVM reading (dB)
L-CH	L-CH	Ⓐ
R-CH	L-CH	Ⓑ Adjust RV21 for minimum reading
R-CH	R-CH	Ⓒ
L-CH	R-CH	Ⓓ Adjust RV21 for minimum reading

L-CH Stereo separation : Ⓐ — Ⓑ

R-CH Stereo separation : Ⓒ — Ⓓ

The separations of both channels should be equal.

Note on Ceramic Filter (CF1, 2) Replacement.

This set employs two ceramic filters (CF1, 2) which should have the same color marking to identify their center frequency. Therefore FM IF offset adjustment by (*A, *B) connection is necessary to match the center frequency of the ceramic filters used with FM intermediate frequency.

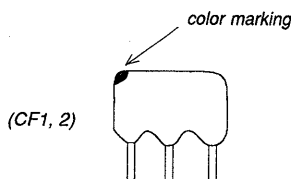

○ : short
× : open

Ceramic filter		Connection		FM intermediate frequency (MHz)
Color mark	Center Frequency (MHz)	*A (D125)	*B (D124)	
White	10.750	×	○	10.750
Red	10.700	×	×	10.700
Black	10.650	○	○	10.650

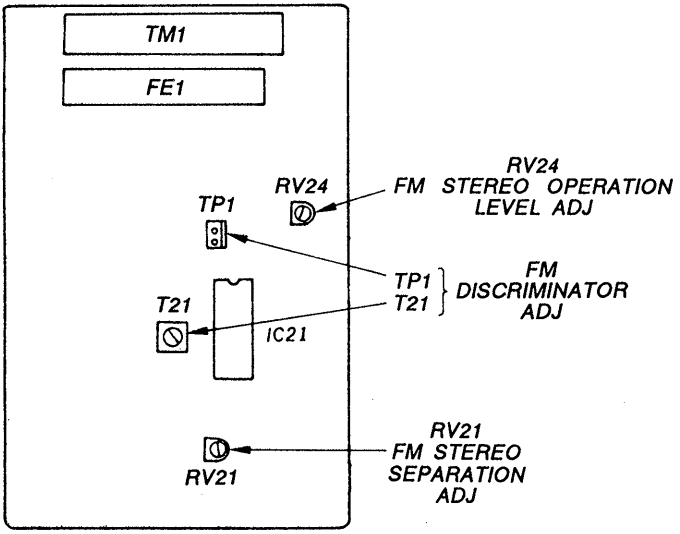

SECTION 4 DIAGRAMS

4-1. PRINTED WIRING BOARDS - MAINS Section - See page 29, 30 Circuit Board Location and Semiconductor Lead Layouts.

● Semiconductor Location

Ref. No.	Location	Ref. No.	Location	Ref. No.	Location
D201	J-25	Q1	C-26	Q753	E-10
D401	J-8	Q21	F-26	Q754	F-9
D403	D-10	Q22	G-26	Q755	D-11
D602	B-12	Q23	E-26	Q756	E-13
D701	F-9	Q24	D-26	Q757	E-11
D702	G-10	Q25	F-24	Q760	D-11
D703	I-11	Q81	D-26	Q761	E-11
D704	J-12	Q82	D-26	Q762	F-13
D705	I-10	Q83	D-26	Q763	D-13
D706	G-10	Q84	C-26	Q764	E-11
D751	E-9	Q251	I-24	Q951	H-9
D752	F-10	Q252	J-26	Q952	I-9
D753	D-13	Q253	J-24	Q953	J-11
D901	J-19	Q254	J-25	Q954	J-11
D951	F-11	Q301	J-6	Q955	I-11
D952	G-9	Q302	J-6	Q956	I-10
D953	I-9	Q303	J-5	Q957	I-11
D954	I-10	Q304	I-6	Q958	I-10
D955	H-9	Q305	I-6	Q959	I-9
D956	I-9	Q306	I-6	Q960	J-10
D962	J-11	Q307	H-6		
D963	J-11	Q309	D-11		
D964	J-11	Q401	G-6		
D965	I-10	Q402	C-10		
D966	J-10	Q403	F-8		
D967	J-10	Q406	J-5		
D968	I-10	Q407	I-6		
D969	I-10	Q408	D-10		
D970	J-11	Q451	G-7		
D971	J-10	Q452	C-9		
D972	C-11	Q602	B-12		
D973	C-11	Q701	F-9		
D974	D-11	Q702	F-9		
D975	C-11	Q703	F-10		
		Q704	G-9		
		Q705	H-10		
IC21	E-25	Q705	H-10		
IC81	C-27	Q706	H-13		
IC251	J-25	Q707	G-10		
IC301	F-8	Q710	H-11		
IC302	H-7	Q711	H-11		
IC303	I-7	Q712	I-13		
IC304	E-8	Q713	G-13		
IC305	D-9	Q714	H-11		
IC306	E-7	Q715	H-10		
IC307	F-8	Q716	H-10		
IC308	E-7	Q717	H-10		
IC401	C-6	Q718	I-9		
IC402	C-8	Q751	E-9		
IC601	C-13	Q752	E-9		

Note:

- : parts extracted from the component side.
- : parts mounted on the conductor side.
- : indicates side identified with part number.
- * , *A , *B : See page 9 for Note on Ceramic Filter (CF1, 2) Replacement.

CND: Canadian

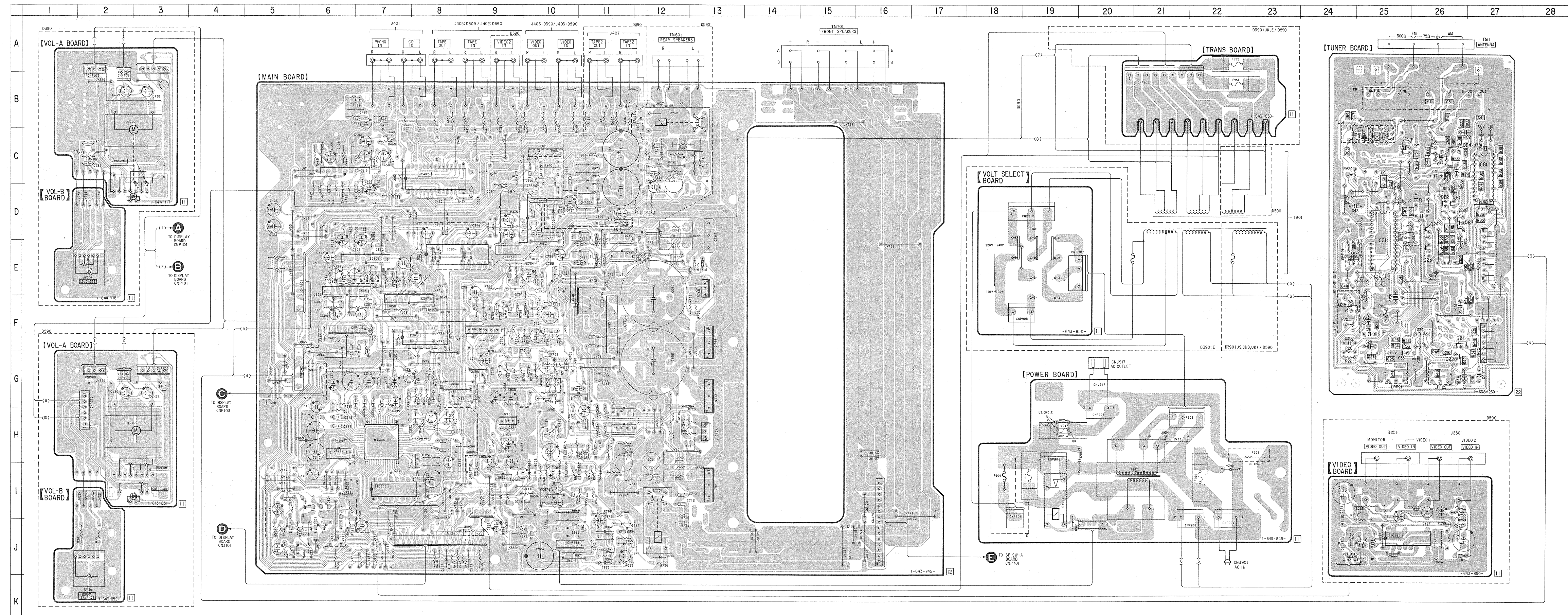

● IC Block Diagrams

IC251 BA7625

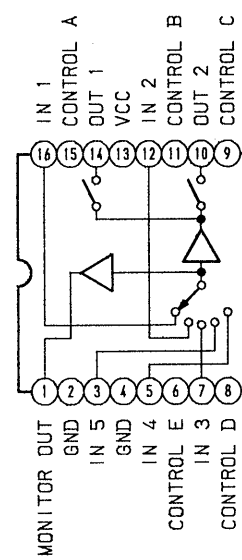

IC301 LC4966

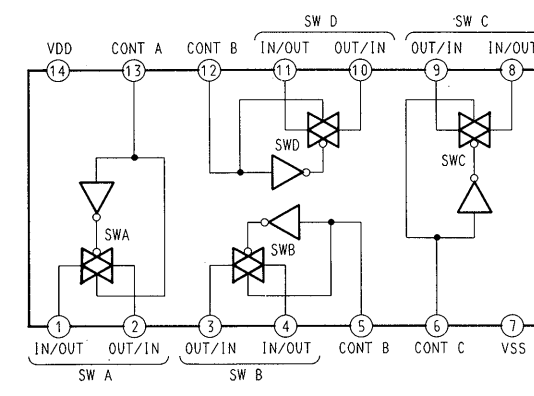

IC303 LM3364K-15

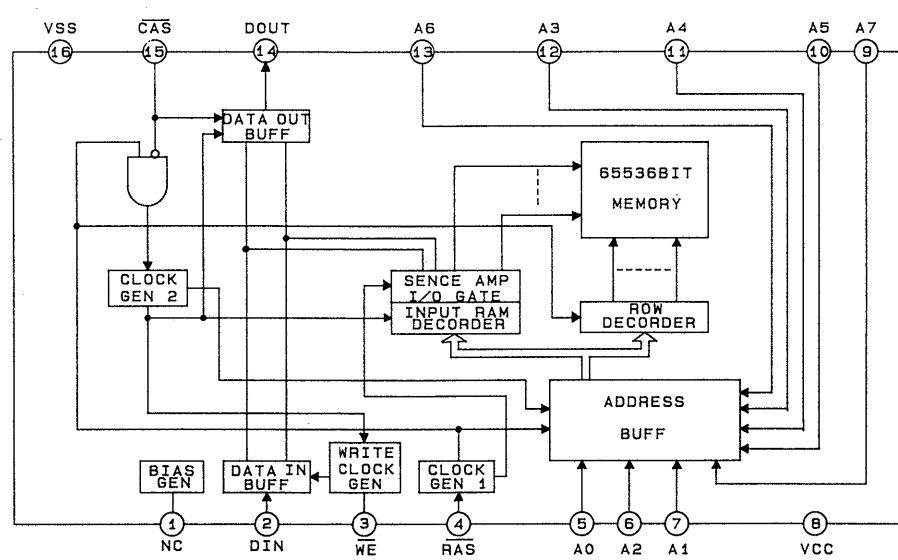

IC304 LC7535

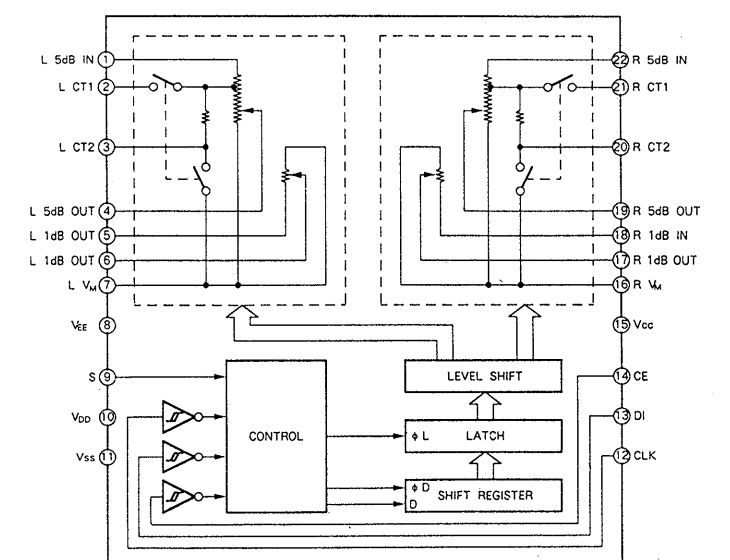

IC402 LC7822

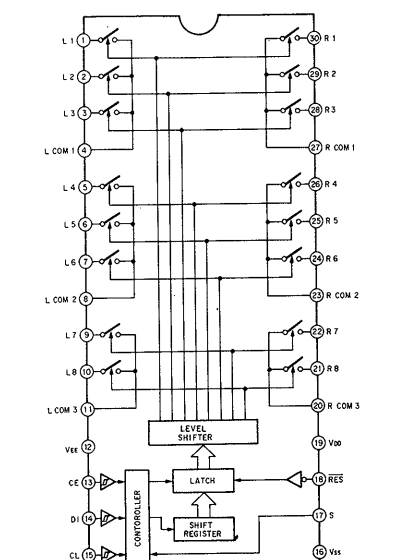

Note:
 * , #, A, B: See page 9 for Note on Ceramic Filter (CF1, 2) Replacement.
 All capacitors are in μF unless otherwise noted. pF: μF F 500WV or less are not indicated except for electrolytics and tantalums.
 All resistors are in Ω and 1/4 W or less unless otherwise specified.

4-2. SCHEMATIC DIAGRAM-MAIN Section-

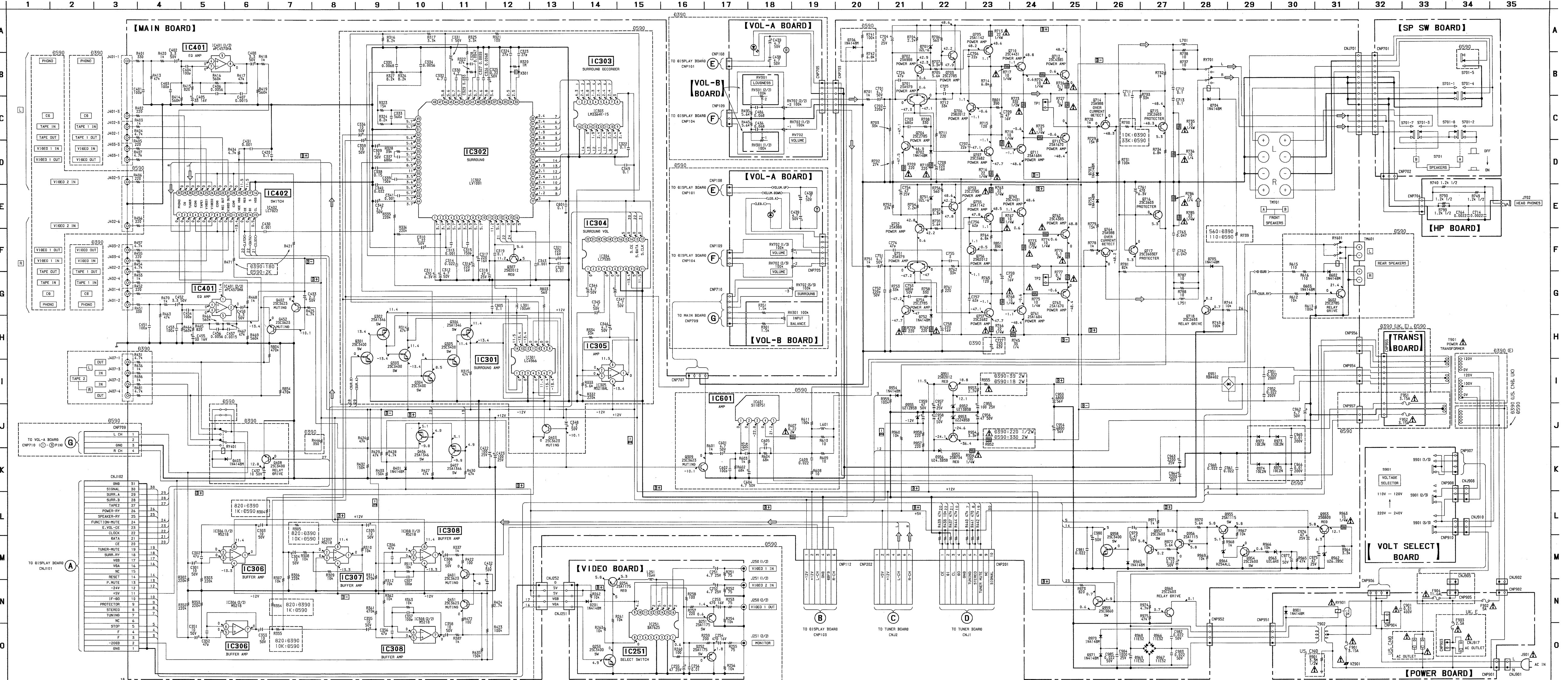

IC302 LV1001M

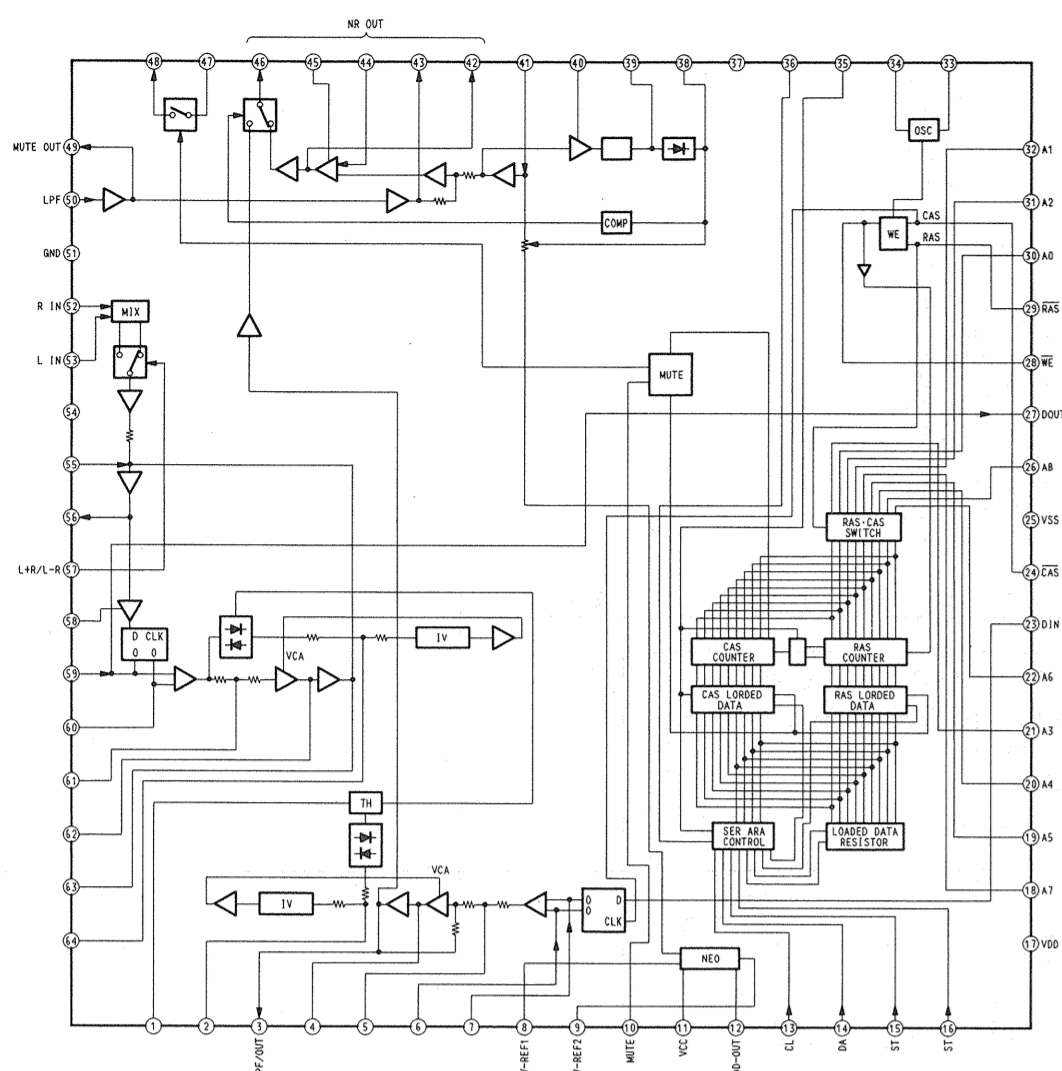

● Semiconductor Location

Ref. No.	Location	Ref. No.	Location
D101	D-10	IC101	E-7
D102	D-10	IC102	D-11
D103	D-10	IC103	E-8
D104	D-10	IC104	F-2
D105	D-10	IC403	C-13
D106	D-10		
D107	D-10	Q101	D-10
D108	D-10	Q102	D-11
D109	E-10	Q103	D-5
D110	E-3	Q104	D-5
D111	D-8	Q108	B-2
D112	E-3	Q110	E-11
D113	E-4	Q404	D-13
D114	F-9	Q405	D-12
D115	E-10	Q407	E-11
D119	E-10	Q408	E-11
D120	F-10	Q409	F-4
D122	G-8	Q454	C-13
D124	G-7	Q455	D-12
D125	F-8		
D126	D-10		
D127	D-10		
D128	D-5		
D129	D-5		
D130	E-5		
D131	D-5		
D132	E-2		
D133	B-3		
D134	E-10		
D135	F-3		
D404	C-11		

4-3. PRINTED WIRING BOARDS-DISPLAY Section- See page 29, 30 Circuit Board Location and Semiconductor Lead Layouts. See page 11 Note.

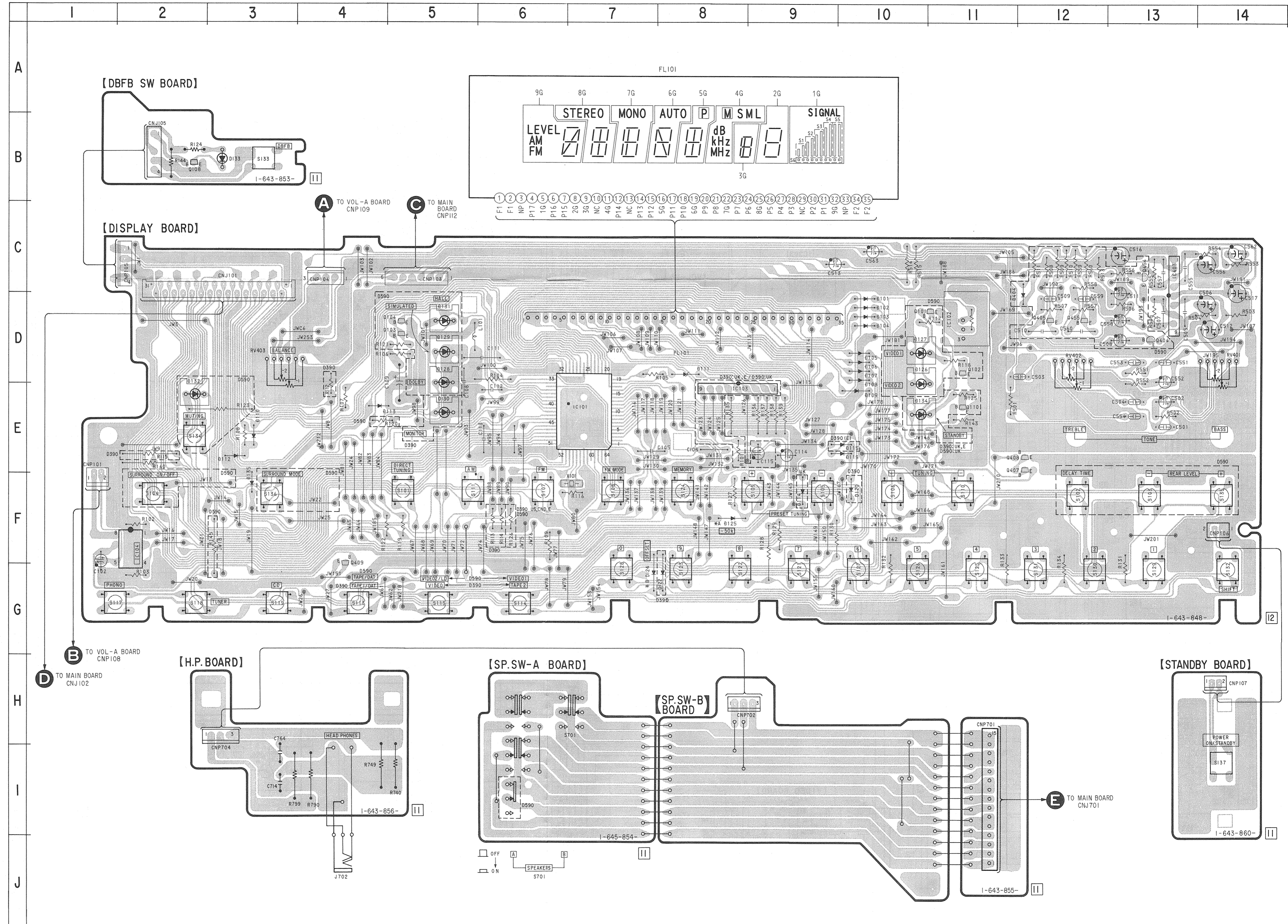

IC Block Diagrams

4-4. SCHEMATIC DIAGRAM-DISPLAY Section - See page 15 Note.

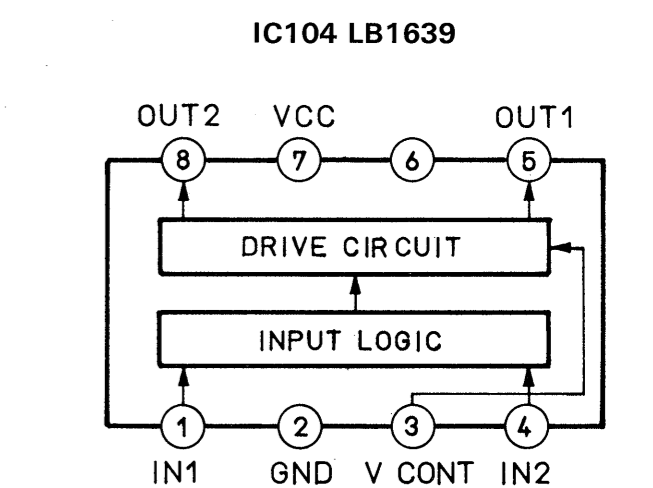
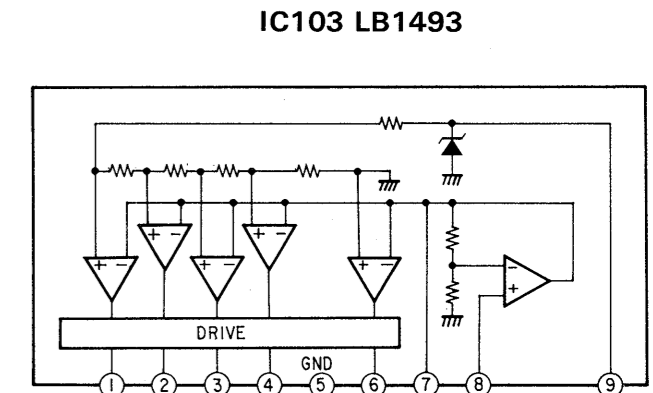
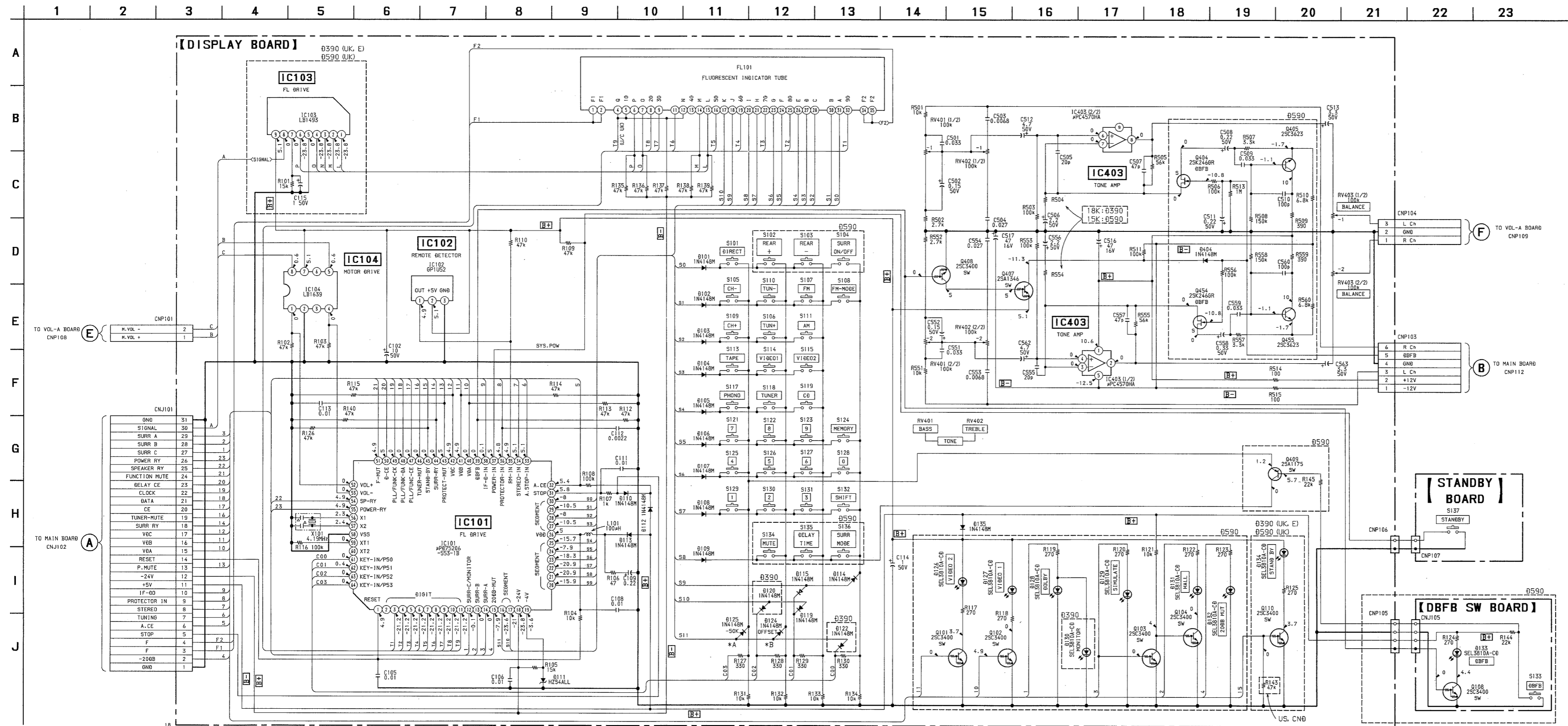

4-6. CIRCUIT BOARDS LOCATION

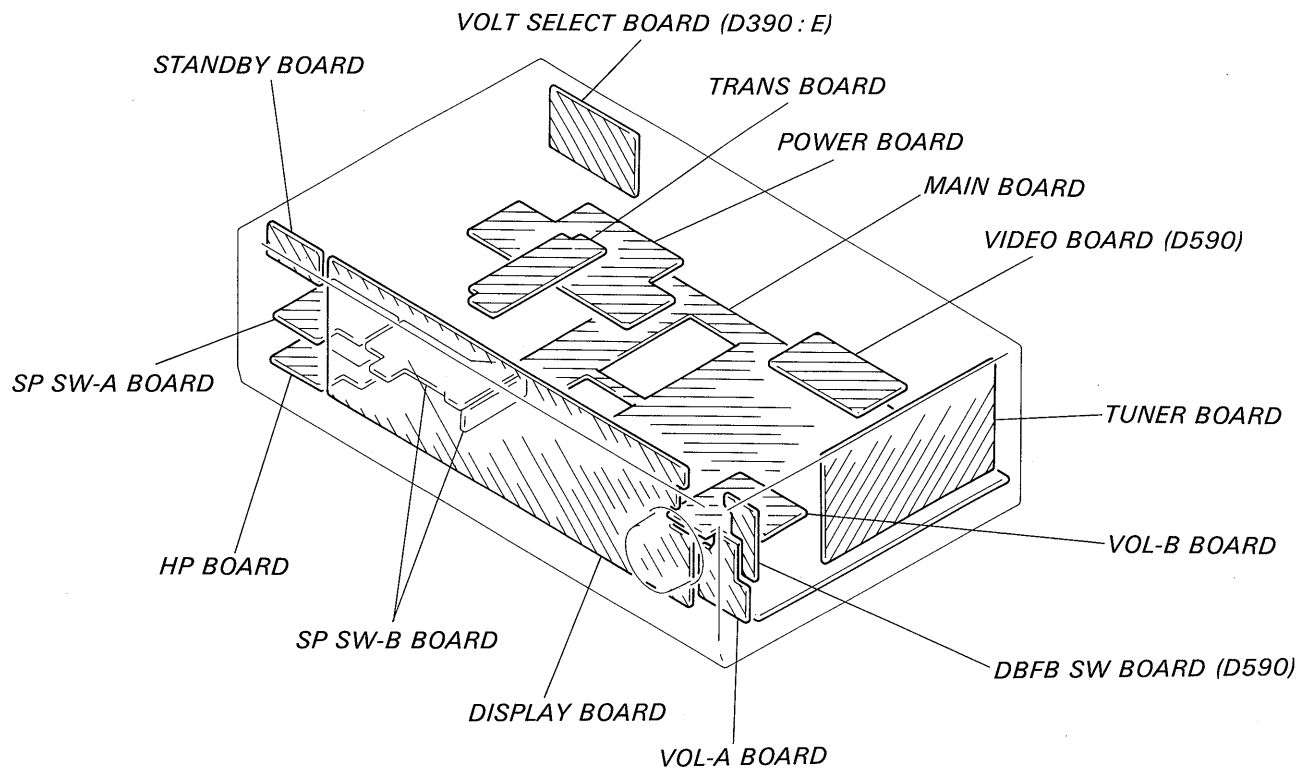

4-7. SEMICONDUCTOR LEAD LAYOUTS

GP1U52XB

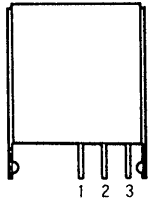

1 Vout
2 Vcc
3 GND

μPD75206GF-726-3BE

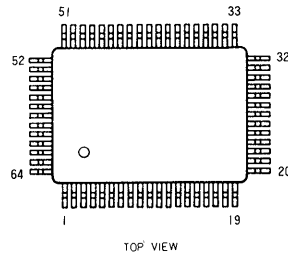

TOP VIEW

**2SA1684-LK
2SC4431-LK**

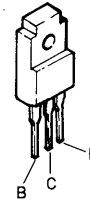

**LB1493
μPC4570HA-1**

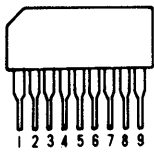

**2SA1142-QPE
2SC2682-QPE
2SD809-K**

letter side

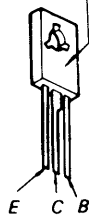

2SA979-FG



LV1001M

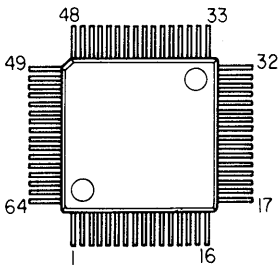

**2SA1175-FEK
2SA1175-HFE
2SC2785-FEK
2SC2785-HFE**

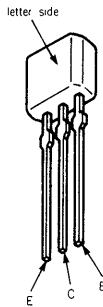

2SA988-PAFAEA

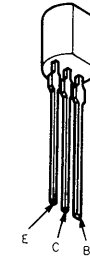

M5218AL

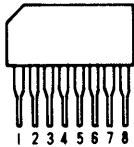

2SB734-34



SI18752

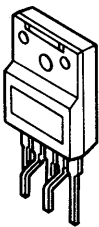

**2SA1670-OPY-LF
2SB1371
2SD2064**

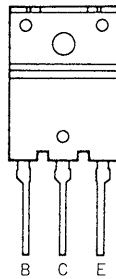

**2SC2603-EF
2SC2669-OY
2SC3113-AB
DTA114ES
DTA124ES
DTC114ES
DTC124ES**

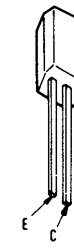

2SC4385-OPY-LF

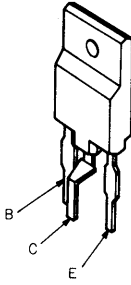

2SD2012

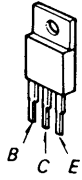

2SK246-GR3

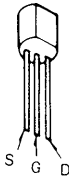

10E2N
1N4148M
UZ-12BSB
UZ-13BSB
UZ-4.3BSB
UZ-6.2BSC

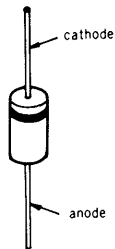

1SS120
HZS4ALL
HZS6C3L
UZ-27BSB

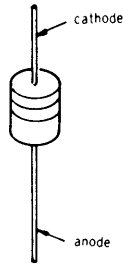

RBA402

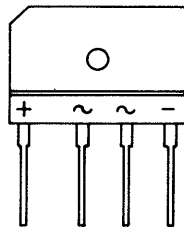

SEL3210S-CD
SEL3810A-CD

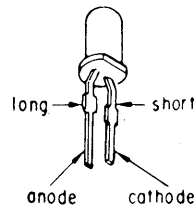

SECTION 5 EXPLODED VIEWS

NOTE:

• -XX, -X mean standardized parts, so they may have some differences from the original one.

• Color Indication of Appearance Parts
Example:

KNOB, BALANCE(WHITE)...(RED)

↑ ↑
Parts color Cabinet's color

- Items marked " * " are not stocked since they are seldom required for routine service. Some delay should be anticipated when ordering these items.
- The mechanical parts with no reference number in the exploded views are not supplied.
- hardware (#mark) list is given in the last of this parts list.

The components identified by mark or dotted line with mark are critical for safety. Replace only with part number specified.

Les composants identifiés par une marque sont critiques pour la sécurité. Ne les remplacer que par une pièce portant le numéro spécifié.

CND : Canadian

5-1. FRONT PANEL SECTION

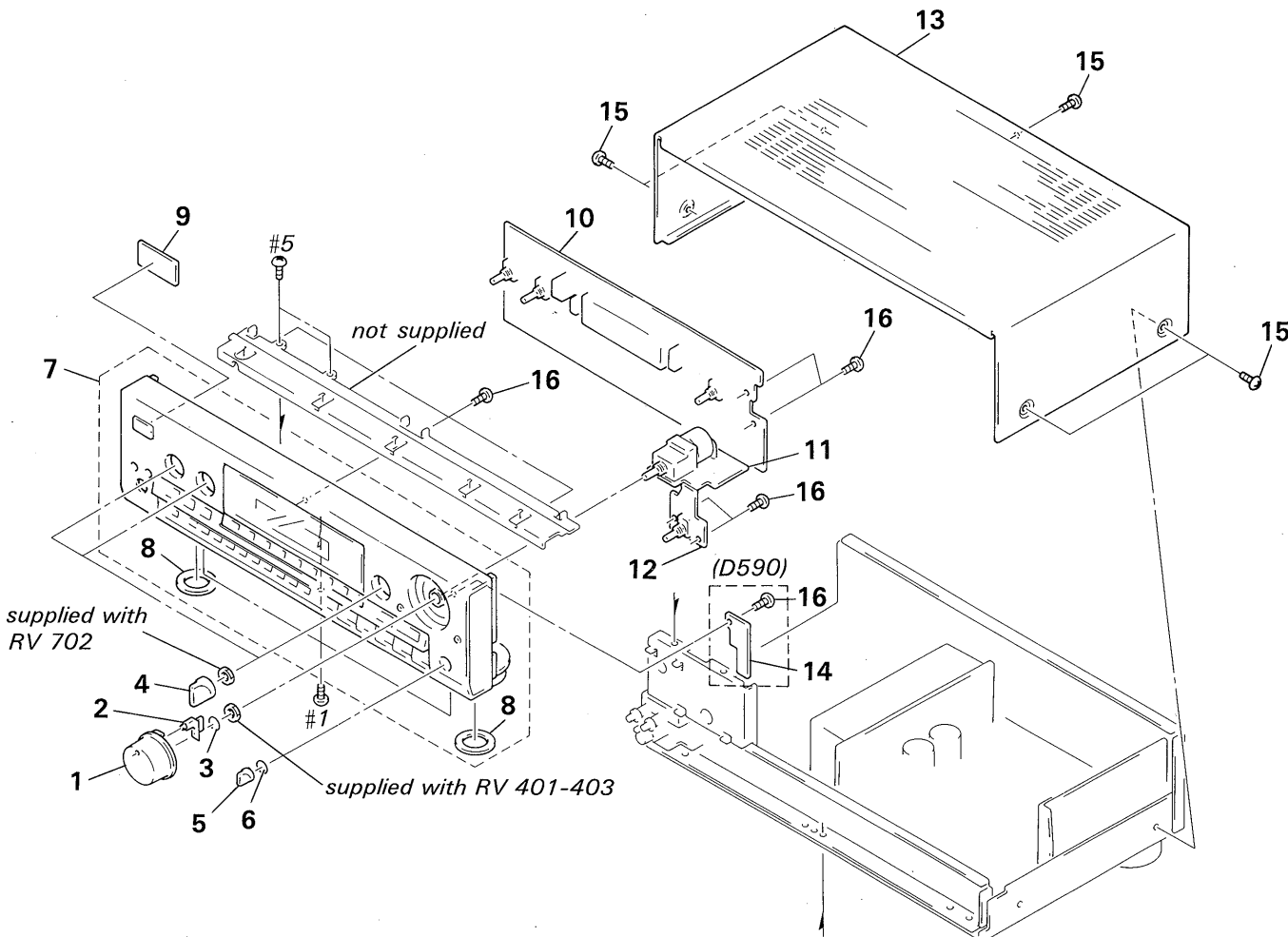



Ref. No.	Part No.	Description	Remark
1	4-943-091-01	KNOB (VOL) (MASTER VOLUME)	
2	4-943-092-01	PLATE (VOL), LIGHT GUIDE	
3	3-350-426-01	SPRING, RING	
4	4-951-803-01	KNOB (DIA. 21), FLAT (BASS/TREBLE/BALANCE)	
5	4-925-014-11	KNOB (DIA. 10) (INPUT BALANCE)	
6	3-356-957-11	SPRING	
7	A-4325-686-A	PANEL ASSY, FRONT (D390:US, CND)	
7	A-4325-687-A	PANEL ASSY, FRONT (D390:UK, E)	
7	A-4325-688-A	PANEL ASSY, FRONT (D590:US, CND)	
7	A-4325-689-A	PANEL ASSY, FRONT (D590:UK)	
8	4-923-836-11	CUSHION	
* 9	1-643-860-11	STANDBY BOARD	

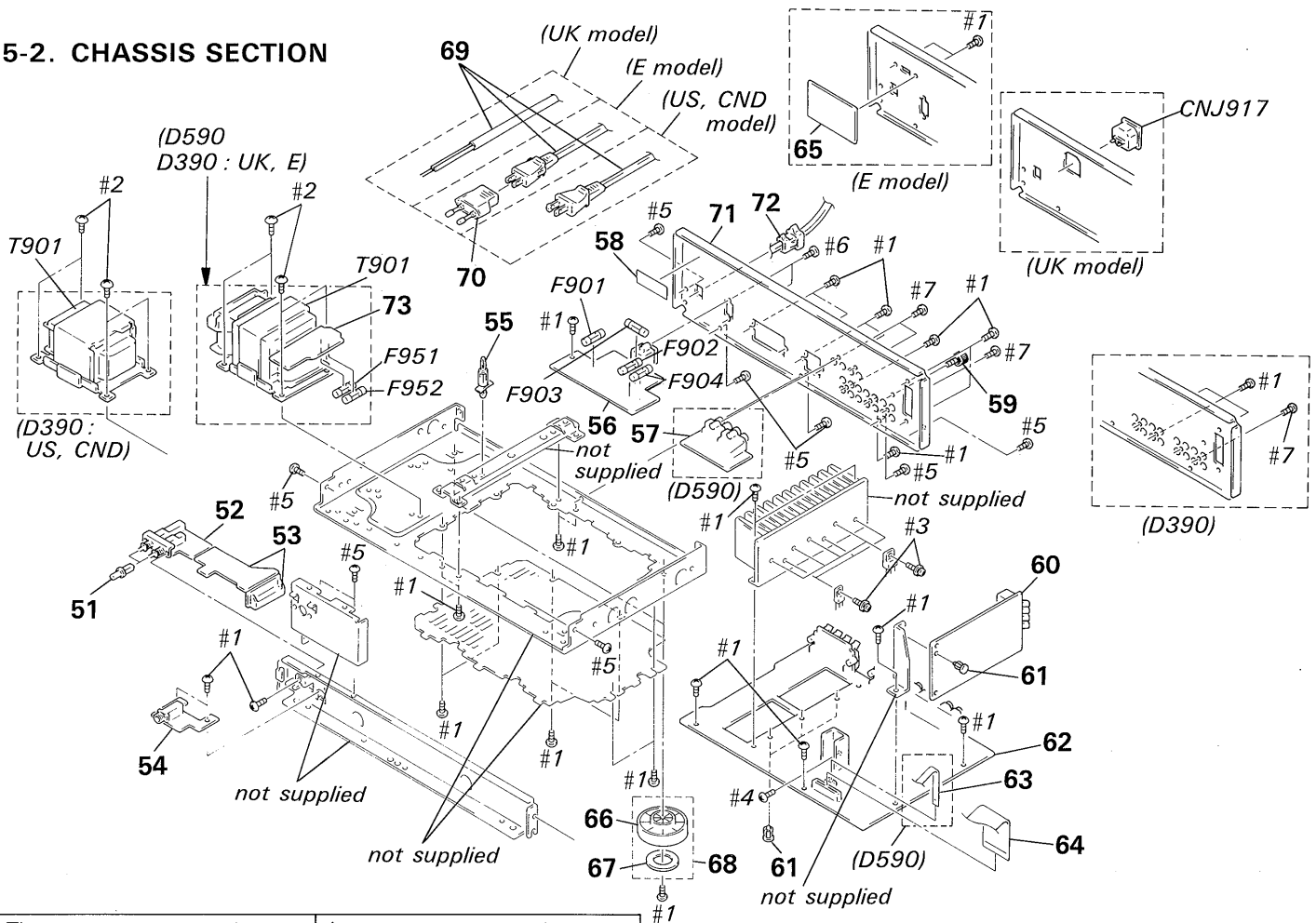

Ref. No.	Part No.	Description	Remark
* 10	A-4347-770-A	DISPLAY BOARD, COMPLETE (D390:US, CND)	
* 10	A-4347-771-A	DISPLAY BOARD, COMPLETE (D390:UK)	
* 10	A-4347-772-A	DISPLAY BOARD, COMPLETE (D390:E)	
* 10	A-4347-785-A	DISPLAY BOARD, COMPLETE (D590:UK)	
* 10	A-4347-786-A	DISPLAY BOARD, COMPLETE (D590:US, CND)	
* 11	1-644-117-11	VOLUME-A BOARD (D390)	
* 11	1-643-851-11	VOLUME-A BOARD (D590)	
* 12	1-644-118-11	VOLUME-B BOARD (D390)	
* 12	1-643-852-11	VOLUME-B BOARD (D590)	
* 13	4-951-795-01	CASE	
* 14	1-643-853-11	DBFB SW BOARD (D590)	
15	3-704-366-01	SCREW (CASE) (M3X8)	
16	4-951-620-01	SCREW (2. 6X8), +BVTP	

















5-2. CHASSIS SECTION



The components identified by mark  or dotted line with mark  are critical for safety. Replace only with part number specified.

Les composants identifiés par une marque  sont critiques pour la sécurité. Ne les remplacer que par une pièce portant le numéro spécifié.

Ref. No.	Part No.	Description	Remark
51	4-951-801-01	BUTTON (S) (SPEAKERS)	
* 52	1-643-854-11	SP SW-A BOARD	
* 53	1-643-855-11	SP SW-B BOARD	
* 54	1-643-856-11	HP BOARD	
* 55	4-924-098-31	HOLDER, PC BOARD	
* 56	1-643-849-11	POWER BOARD	
* 57	1-643-850-11	VIDEO BOARD (D590)	
* 58	3-703-044-26	LABEL, CAUTION (D390:US, CND/D590:US, CND)	
59	4-947-010-01	SCREW, FEEDER FIXED	
* 60	A-4347-775-A	TUNER BOARD, COMPLETE (D390:E)	
60	A-4356-360-A	TUNER BOARD, COMPLETE (D390:US, CND/D590:US, CND)	
60	A-4356-361-A	TUNER BOARD, COMPLETE (D390:UK/D590:UK)	
61	4-812-134-11	RIVET NYLON, 3.5	
* 62	A-4347-762-A	MAIN BOARD, COMPLETE (D390:US, CND)	
* 62	A-4347-763-A	MAIN BOARD, COMPLETE (D390:UK, E)	
* 62	A-4347-776-A	MAIN BOARD, COMPLETE (D590:US, CND)	
* 62	A-4347-777-A	MAIN BOARD, COMPLETE (D590:UK)	
63	1-696-457-11	WIRE (FLAT TYPE) (5 CORE) (D590)	
64	1-696-456-11	WIRE (FLAT TYPE) (31 CORE)	
* 65	1-643-859-11	VOLT SELECT BOARD (D390:E)	
66	3-318-688-31	FOOT (F58175S) (D390:UK, E/D590:UK)	
66	3-318-688-51	FOOT (F58175S) (D390:US, CND/D590:US, CND)	
67	4-923-836-11	CUSHION	
68	X-4941-291-1	FOOT ASSY (F58175S) (D390:US, CND/D590:US, CND)	
68	X-4941-292-1	FOOT ASSY (F58175S) (D390:UK, E/D590:UK)	
 69	1-575-652-11	CORD, POWER (D390:UK/D590:UK)	
 69	1-575-653-11	CORD, POWER (D390:E)	
 69	1-690-609-11	CORD, POWER (D390:US, CND/D590:US, CND)	

Ref. No.	Part No.	Description	Remark
 70	1-526-565-00	AC PLUG ADAPTOR (D390:E)	
* 71	4-951-791-01	PANEL, BACK (D590:US)	
* 71	4-951-791-11	PANEL, BACK (D590:CND)	
* 71	4-951-791-21	PANEL, BACK (D590:UK)	
* 71	4-951-791-31	PANEL, BACK (D390:E)	
* 71	4-951-791-41	PANEL, BACK (D390:US)	
* 71	4-951-791-51	PANEL, BACK (D390:CND)	
* 71	4-951-791-61	PANEL, BACK (D390:UK)	
72	3-703-571-11	BUSHING (S) (4516), CORD (D390:E)	
72	3-703-244-00	BUSHING (2104), CORD (D390:US, CND, UK/D590)	
* 73	1-643-858-11	TRANS BOARD (D390:UK, E/D590)	
 CNJ917	1-526-751-00	OUTLET, AC (D390:UK/D590:UK)	
 F901	1-532-286-00	FUSE, TIME LAG (T2.5AL) (D390:UK, E/D590:UK)	
 F901	1-576-107-11	FUSE (3.15A/250V) (D390:US, CND/D590:US, CND)	
 F902	1-532-259-00	FUSE, TIME LAG (T1.6AL) (D390:UK, E/D590:UK)	
 F902	1-576-109-11	FUSE (5A/125V) (D390:US, CND/D590:US, CND)	
 F903	1-532-286-00	FUSE, TIME LAG (T2.5AL) (D390:UK, E/D590:UK)	
 F904	1-532-259-00	FUSE, TIME LAG (T1.6AL) (D390:E)	
 F951	1-532-237-00	FUSE, TIME LAG (T3.15AL) (D590)	
 F952	1-532-237-00	FUSE, TIME LAG (T3.15AL) (D590)	
 T901	1-450-365-21	TRANSFORMER, POWER (D390:US)	
 T901	1-450-620-21	TRANSFORMER, POWER (D390:CND)	
 T901	1-450-833-11	TRANSFORMER, POWER (D590:US, CND)	
 T901	1-450-834-11	TRANSFORMER, POWER (D590:UK)	
 T901	1-450-835-11	TRANSFORMER, POWER (D390:E)	
 T901	1-450-934-11	TRANSFORMER, POWER (D390:UK)	

SECTION 6 ELECTRICAL PARTS LIST

DISPLAY

DBFB SW

HP

POWER

SP SW-A

SP SW-B

STANDBY

TRANS

VIDEO

VOLT SELECT

VOL-A

VOL-B

NOTE:

- Due to standardization, replacements in the parts list may be different from the parts specified in the diagrams or the components used on the set.
- -XX and -X mean standardized parts, so they may have some difference from the original one.
- RESISTORS
All resistors are in ohms.
METAL: Metal-film resistor.
METAL OXIDE: Metal oxide-film resistor.
F: nonflammable

- Items marked "*" are not stocked since they are seldom required for routine service. Some delay should be anticipated when ordering these items.
- SEMICONDUCTORS
In each case, u: μ , for example:
uA ..: μ A. uPA ..: μ PA.
uPB ..: μ PB. uPC ..: μ PC. uPD ..: μ PD.
- CAPACITORS
uF: μ F
- COILS
uH: μ H

When indicating parts by reference number, please include the board.

The components identified by mark Δ or dotted line with mark Δ are critical for safety. Replace only with part number specified.

Les composants identifiés par une marque Δ sont critiques pour la sécurité. Ne les remplacer que par une pièce portant le numéro spécifié.

CND: Canadian

Ref. No.	Part No.	Description	Remark
*	A-4347-770-A	DISPLAY BOARD, COMPLETE	(D390:US, CND)
*	A-4347-771-A	DISPLAY BOARD, COMPLETE	(D390:UK)
*	A-4347-772-A	DISPLAY BOARD, COMPLETE	(D390:E)
*	A-4347-785-A	DISPLAY BOARD, COMPLETE	(D590:UK)
*	A-4347-786-A	DISPLAY BOARD, COMPLETE	(D590:US, CND)

*	1-643-853-11	DBFB SW BOARD	(D590)

*	1-643-856-11	HP BOARD	

*	1-643-849-11	POWER BOARD	

*	1-643-854-11	SP SW-A BOARD	

*	1-643-855-11	SP SW-B BOARD	

*	1-643-860-11	STANDBY BOARD	

*	1-643-858-11	TRANS BOARD	(D390:UK, E/D590)

*	1-643-850-11	VIDEO BOARD	(D590)

*	1-643-859-11	VOLT SELECT BOARD	(D390:E)

*	1-643-851-11	VOL-A BOARD	(D590)
*	1-644-117-11	VOL-A BOARD	(D390)

*	1-643-852-11	VOL-B BOARD	(D590)
*	1-644-118-11	VOL-B BOARD	(D390)

*	4-921-941-01	CUSHION	(FL)
*	4-942-204-01	PLATE, GROUND	
*	4-943-107-11	HOLDER	(FL TUBE)
*	1-533-217-31	HOLDER, FUSE	(D390:E)
*	1-540-038-11	OUTLET, AC	(NONPOLAR) (1P) (D390:E)

Ref. No.	Part No.	Description	Remark
*	1-564-509-11	PLUG, CONNECTOR 6P	(D590)
< CAPACITOR >			
C102	1-126-157-11	ELECT	10uF 20% 16V
C105	1-161-379-00	CERAMIC	0.01uF 20% 25V
C106	1-161-379-00	CERAMIC	0.01uF 20% 25V
C108	1-161-379-00	CERAMIC	0.01uF 20% 25V
C109	1-125-486-11	DOUBLE LAYERS	0.22F 5.5V
C111	1-161-379-00	CERAMIC	0.01uF 20% 25V
C112	1-161-375-00	CERAMIC	0.0022uF 20% 50V
C113	1-161-379-00	CERAMIC	0.01uF 20% 25V
C114	1-126-301-11	ELECT	1uF 20% 50V
C115	1-126-301-11	ELECT	1uF 20% 50V (D390:UK, E/D590:UK)
C251	1-124-927-11	ELECT	4.7uF 20% 100V (D590)
C252	1-124-927-11	ELECT	4.7uF 20% 100V (D590)
C253	1-126-103-11	ELECT	470uF 20% 16V (D590)
C254	1-126-103-11	ELECT	470uF 20% 16V (D590)
C255	1-124-477-11	ELECT	47uF 20% 25V (D590)
C256	1-161-379-00	CERAMIC	0.01uF 20% 25V (D590)
C436	1-136-163-00	FILM	0.068uF 5% 50V (D390)
C438	1-124-927-11	ELECT	4.7uF 20% 100V
C439	1-124-927-11	ELECT	4.7uF 20% 100V
C486	1-136-163-00	FILM	0.068uF 5% 50V (D390)
C501	1-130-489-00	MYLAR	0.033uF 5% 50V
C502	1-124-250-00	ELECT	0.15uF 20% 50V
C503	1-130-481-00	MYLAR	0.0068uF 5% 50V
C504	1-130-488-00	MYLAR	0.027uF 5% 50V
C505	1-162-206-31	CERAMIC	20PF 5% 50V
C506	1-124-925-11	ELECT	2.2uF 20% 100V
C507	1-162-215-31	CERAMIC	47PF 5% 50V
C508	1-124-252-00	ELECT	0.33uF 20% 50V (D590)
C509	1-130-489-00	MYLAR	0.033uF 5% 50V (D590)
C510	1-162-282-31	CERAMIC	100PF 10% 50V (D590)
C511	1-124-464-11	ELECT	0.22uF 20% 50V (D590)
C512	1-124-927-11	ELECT	4.7uF 20% 100V
C513	1-126-162-11	ELECT	3.3uF 20% 50V
C515	1-124-925-11	ELECT	2.2uF 20% 100V (D590)
C516	1-124-477-11	ELECT	47uF 20% 25V
C517	1-124-477-11	ELECT	47uF 20% 25V

DISPLAY

DBFB SW

HP

POWER

SP SW-A

SP SW-B

STANDBY

TRANS

VIDEO

VOLT SELECT

VOL-A

VOL-B

Ref. No.	Part No.	Description	Remark		
C551	1-130-489-00	MYLAR	0.033uF	5%	50V
C552	1-124-250-00	ELECT	0.15uF	20%	50V
C553	1-130-481-00	MYLAR	0.0068uF	5%	50V
C554	1-130-488-00	MYLAR	0.027uF	5%	50V
C555	1-162-206-31	CERAMIC	20PF	5%	50V
C556	1-124-925-11	ELECT	2.2uF	20%	100V
C557	1-162-215-31	CERAMIC	47PF	5%	50V
C558	1-124-252-00	ELECT	0.33uF	20%	50V (D590)
C559	1-130-489-00	MYLAR	0.033uF	5%	50V (D590)
C560	1-162-282-31	CERAMIC	100PF	10%	50V (D590)
C562	1-124-927-11	ELECT	4.7uF	20%	100V
C563	1-126-162-11	ELECT	3.3uF	20%	50V
C714	1-164-089-11	CERAMIC	0.0022uF		50V
C764	1-164-089-11	CERAMIC	0.0022uF		50V
△C901	1-161-744-00	CERAMIC	0.01uF		400V

< JACK >

- * CNJ101 1-568-873-11 SOCKET, CONNECTOR 31P
- * CNJ251 1-568-824-11 SOCKET, CONNECTOR 5P (D590)
- △CNJ917 1-540-057-11 OUTLET, AC (POLAR)
(D390:US, CND/D590:US, CND)

< CONNECTOR >

- * CNP101 1-568-951-11 PIN, CONNECTOR 2P
- * CNP103 1-564-521-11 PLUG, CONNECTOR 6P
- * CNP104 1-564-518-11 PLUG, CONNECTOR 3P
- * CNP105 1-564-519-11 PLUG, CONNECTOR 4P (D590)
- * CNP106 1-568-951-11 PIN, CONNECTOR 2P
- * CNP107 1-568-951-11 PIN, CONNECTOR 2P
- * CNP108 1-568-951-11 PIN, CONNECTOR 2P
- * CNP109 1-564-506-11 PLUG, CONNECTOR 3P
- CNP701 1-573-109-11 PIN, CONNECTOR 15P
- * CNP702 1-564-518-11 PLUG, CONNECTOR 3P
- * CNP704 1-564-518-11 PLUG, CONNECTOR 3P
- * CNP705 1-564-508-11 PLUG, CONNECTOR 5P
- * CNP901 1-564-321-00 PIN, CONNECTOR 2P
- * CNP902 1-580-230-11 PIN, CONNECTOR (PC BOARD) 3P
- * CNP903 1-580-230-11 PIN, CONNECTOR (PC BOARD) 3P (UK)
- * CNP904 1-580-230-11 PIN, CONNECTOR (PC BOARD) 3P
- CNP905 1-564-320-00 PIN, CONNECTOR (B2P-VH) 2P (D390:E)
- * CNP906 1-564-241-00 PIN, CONNECTOR (B4P-VH) 4P (D390:E)
- * CNP907 1-564-241-00 PIN, CONNECTOR (B4P-VH) 4P (D390:E)
- * CNP908 1-564-321-00 PIN, CONNECTOR 2P (D390:E)
- * CNP910 1-564-687-11 PIN, CONNECTOR 3P (D390:E)
- CNP951 1-564-507-11 PLUG, CONNECTOR 4P
- * CNP955 1-564-905-11 PIN, CONNECTOR 9P (D590)
- * CNP955 1-564-243-00 PIN, CONNECTOR 6P (D390:UK, E)

Ref. No.	Part No.	Description	Remark
< DIODE >			
D101	8-719-987-63	DIODE 1N4148M	
D102	8-719-987-63	DIODE 1N4148M	
D103	8-719-987-63	DIODE 1N4148M	
D104	8-719-987-63	DIODE 1N4148M	
D105	8-719-987-63	DIODE 1N4148M	
D106	8-719-987-63	DIODE 1N4148M	
D107	8-719-987-63	DIODE 1N4148M	
D108	8-719-987-63	DIODE 1N4148M	
D109	8-719-987-63	DIODE 1N4148M	
D110	8-719-987-63	DIODE 1N4148M	
D111	8-719-985-53	DIODE HZS4ALL	
D112	8-719-987-63	DIODE 1N4148M	
D113	8-719-987-63	DIODE 1N4148M	
D114	8-719-987-63	DIODE 1N4148M	(D390:UK/D590:UK)
D115	8-719-987-63	DIODE 1N4148M	(D390:E)
D119	8-719-987-63	DIODE 1N4148M	(D590)
D120	8-719-987-63	DIODE 1N4148M	(D390)
D122	8-719-987-63	DIODE 1N4148M	(D390)
D124	8-719-987-63	DIODE 1N4148M	
D125	8-719-987-63	DIODE 1N4148M	
D126	8-719-313-72	LED SEL3810A-CD (VIDEO2)	(D590)
D127	8-719-313-72	LED SEL3810A-CD (VIDEO1)	(D590)
D128	8-719-313-72	LED SEL3810A-CD (DOLBY)	(D590)
D129	8-719-313-72	LED SEL3810A-CD (SIMULATED)	(D590)
D130	8-719-313-72	LED SEL3810A-CD (MONITOR)	(D390)
D131	8-719-313-72	LED SEL3810A-CD (HALL)	(D590)
D132	8-719-313-72	LED SEL3810A-CD (MUTING)	(D590)
D133	8-719-313-72	LED SEL3810A-CD (DBFB)	(D590)
D134	8-719-313-69	DIODE SEL3210S-CD (STANDBY)	(D390:UK, E/D590:UK)
D135	8-719-987-63	DIODE 1N4148M	
D201	8-719-987-63	DIODE 1N4148M	(D590)
D404	8-719-987-63	DIODE 1N4148M	(D590)
D901	8-719-987-63	DIODE 1N4148M	
< FUSE >			
F901	1-533-217-31	HOLDER, FUSE (D390:US, CND, UK, D590)	
F902	1-533-217-31	HOLDER, FUSE (D390:US, CND, UK, D590)	
F903	1-533-217-31	HOLDER, FUSE (D390:UK/D590:UK)	
F951	1-533-217-31	HOLDER, FUSE (D590)	
F952	1-533-217-31	HOLDER, FUSE (D590)	
< FILTER >			
FL101	1-519-731-11	INDICATOR TUBE, FLUORESCENT	
< IC >			
IC101	8-759-083-97	IC uPD75206GF-726-3BE	
IC102	8-749-920-83	IC GP1U52XB	

The components identified by mark △ or dotted line with mark △ are critical for safety. Replace only with part number specified.

Les composants identifiés par une marque △ sont critiques pour la sécurité. Ne les remplacer que par une pièce portant le numéro spécifié.

DISPLAY

DBFB SW

HP

POWER

SP SW-A

SP SW-B

STANDBY

TRANS

VIDEO

VOLT SELECT

VOL-A

VOL-B

Ref. No.	Part No.	Description	Remark
IC103	8-759-800-95	IC LB1493 (D390:UK, E/D590:UK)	
IC104	8-759-820-62	IC LB1639	
IC251	8-759-991-77	IC BA7625 (D590)	
IC403	8-759-112-93	IC uPC4570HA-1	
< JACK >			
* J250	1-695-317-21	JACK, PIN 2P (VIDEO1 IN/OUT) (D590)	
* J251	1-695-317-21	JACK, PIN 2P (VIDEO2 IN/OUT) (D590)	
J402	1-691-887-11	JACK, PIN 6P (TAPE IN/TAPE OUT/VIDEO1 OUT)	
J702	1-568-515-21	JACK (LARGE TYPE) (HEADPHONES)	
< COIL >			
L101	1-410-521-11	INDUCTOR 100uH	
L251	1-410-509-11	INDUCTOR 10uH (D590)	
< TRANSISTOR >			
Q101	8-729-900-36	TRANSISTOR DTC124ES (D590)	
Q102	8-729-900-36	TRANSISTOR DTC124ES (D590)	
Q103	8-729-900-36	TRANSISTOR DTC124ES (D590)	
Q104	8-729-900-36	TRANSISTOR DTC124ES (D590)	
Q108	8-729-900-36	TRANSISTOR DTC124ES (D590)	
Q110	8-729-900-36	TRANSISTOR DTC124ES (D390:UK, E/D590:UK)	
Q251	8-729-119-77	TRANSISTOR 2SA1175-FEK (D590)	
Q252	8-729-119-77	TRANSISTOR 2SA1175-FEK (D590)	
Q253	8-729-900-36	TRANSISTOR DTC124ES (D590)	
Q254	8-729-119-77	TRANSISTOR 2SA1175-FEK (D590)	
Q404	8-729-202-67	TRANSISTOR 2SK246-GR3 (D590)	
Q405	8-729-620-05	TRANSISTOR 2SC2603-EF (D590)	
Q407	8-729-900-63	TRANSISTOR DTA124ES	
Q408	8-729-900-36	TRANSISTOR DTC124ES	
Q409	8-729-119-77	TRANSISTOR 2SA1175-FEK (D590)	
Q454	8-729-202-67	TRANSISTOR 2SK246-GR3 (D590)	
Q455	8-729-620-05	TRANSISTOR 2SC2603-EF (D590)	
< RESISTOR >			
R101	1-249-431-11	CARBON 15K 5% 1/4W (D390:UK, E/D590:UK)	
R102	1-249-437-11	CARBON 47K 5% 1/4W	
R103	1-249-437-11	CARBON 47K 5% 1/4W	
R104	1-249-429-11	CARBON 10K 5% 1/4W	
R105	1-249-431-11	CARBON 15K 5% 1/4W	
R106	1-249-401-11	CARBON 47 5% 1/4W	
R107	1-249-417-11	CARBON 1K 5% 1/4W	
R108	1-249-441-11	CARBON 100K 5% 1/4W	
R109	1-249-437-11	CARBON 47K 5% 1/4W	
R112	1-249-437-11	CARBON 47K 5% 1/4W (D390)	
R113	1-249-437-11	CARBON 47K 5% 1/4W (D390)	
R114	1-249-437-11	CARBON 47K 5% 1/4W (D390)	
R115	1-249-437-11	CARBON 47K 5% 1/4W (D390)	

Ref. No.	Part No.	Description	Remark
R116	1-249-441-11	CARBON 100K 5% 1/4W	
R117	1-249-410-11	CARBON 270 5% 1/4W (D590)	
R118	1-249-410-11	CARBON 270 5% 1/4W (D590)	
R119	1-249-410-11	CARBON 270 5% 1/4W	
R120	1-249-410-11	CARBON 270 5% 1/4W (D590)	
R121	1-249-429-11	CARBON 10K 5% 1/4W (D590)	
R122	1-249-410-11	CARBON 270 5% 1/4W (D590)	
R123	1-249-410-11	CARBON 270 5% 1/4W (D590)	
R124	1-249-410-11	CARBON 270 5% 1/4W (D590)	
R125	1-249-410-11	CARBON 270 5% 1/4W (D390:UK, E/D590:UK)	
R126	1-249-437-11	CARBON 47K 5% 1/4W (D390:US, CND, E, D590)	
R127	1-249-411-11	CARBON 330 5% 1/4W	
R128	1-249-411-11	CARBON 330 5% 1/4W	
R129	1-249-411-11	CARBON 330 5% 1/4W	
R130	1-249-411-11	CARBON 330 5% 1/4W	
R131	1-249-429-11	CARBON 10K 5% 1/4W	
R132	1-249-429-11	CARBON 10K 5% 1/4W	
R133	1-249-429-11	CARBON 10K 5% 1/4W	
R134	1-249-429-11	CARBON 10K 5% 1/4W	
R135	1-249-437-11	CARBON 47K 5% 1/4W	
R136	1-249-437-11	CARBON 47K 5% 1/4W	
R137	1-249-437-11	CARBON 47K 5% 1/4W	
R138	1-249-437-11	CARBON 47K 5% 1/4W	
R139	1-249-437-11	CARBON 47K 5% 1/4W	
R140	1-249-437-11	CARBON 47K 5% 1/4W	
R143	1-249-437-11	CARBON 47K 5% 1/4W (D590:US, CND)	
R144	1-249-433-11	CARBON 22K 5% 1/4W (D590)	
R145	1-249-433-11	CARBON 22K 5% 1/4W (D590)	
R251	1-247-804-11	CARBON 75 5% 1/4W (D590)	
R252	1-247-804-11	CARBON 75 5% 1/4W (D590)	
R253	1-247-804-11	CARBON 75 5% 1/4W (D590)	
R254	1-249-429-11	CARBON 10K 5% 1/4W (D590)	
R255	1-247-804-11	CARBON 75 5% 1/4W (D590)	
R256	1-249-429-11	CARBON 10K 5% 1/4W (D590)	
△R257	1-249-409-11	CARBON 220 5% 1/4W (D590)	
R258	1-249-405-11	CARBON 100 5% 1/4W (D590)	
R259	1-247-814-11	CARBON 200 5% 1/4W (D590)	
R260	1-249-405-11	CARBON 100 5% 1/4W (D590)	
R261	1-249-429-11	CARBON 10K 5% 1/4W (D590)	
R262	1-249-429-11	CARBON 10K 5% 1/4W (D590)	
R263	1-249-429-11	CARBON 10K 5% 1/4W (D590)	
R301	1-249-419-11	CARBON 1.5K 5% 1/4W (D590)	
R351	1-249-419-11	CARBON 1.5K 5% 1/4W (D590)	
R445	1-249-426-11	CARBON 5.6K 5% 1/4W (D390)	
R495	1-249-426-11	CARBON 5.6K 5% 1/4W (D390)	
R501	1-249-429-11	CARBON 10K 5% 1/4W	
R502	1-249-422-11	CARBON 2.7K 5% 1/4W	
R503	1-249-441-11	CARBON 100K 5% 1/4W	

The components identified by mark Δ or dotted line with mark Δ are critical for safety. Replace only with part number specified.

Les composants identifiés par une marque Δ sont critiques pour la sécurité. Ne les remplacer que par une pièce portant le numéro spécifié.

DISPLAY

DBFB SW

HP

POWER

SP SW-A

SP SW-B

STANDBY

TRANS

VIDEO

VOLT SELECT

VOL-A

VOL-B

Ref. No.	Part No.	Description	Remark
R504	1-249-431-11	CARBON	15K 5% 1/4W (D590)
R504	1-249-432-11	CARBON	18K 5% 1/4W (D390)
R505	1-249-438-11	CARBON	56K 5% 1/4W
R506	1-249-441-11	CARBON	100K 5% 1/4W (D590)
R507	1-249-423-11	CARBON	3.3K 5% 1/4W (D590)
R508	1-247-883-00	CARBON	150K 5% 1/4W (D590)
R509	1-249-412-11	CARBON	390 5% 1/4W (D590)
R510	1-249-427-11	CARBON	6.8K 5% 1/4W (D590)
R511	1-249-441-11	CARBON	100K 5% 1/4W
R513	1-247-903-00	CARBON	1M 5% 1/4W (D590)
R514	1-249-405-11	CARBON	100 5% 1/4W
R515	1-249-405-11	CARBON	100 5% 1/4W
R551	1-249-429-11	CARBON	10K 5% 1/4W
R552	1-249-422-11	CARBON	2.7K 5% 1/4W
R553	1-249-441-11	CARBON	100K 5% 1/4W
R554	1-249-431-11	CARBON	15K 5% 1/4W (D590)
R554	1-249-432-11	CARBON	18K 5% 1/4W (D390)
R555	1-249-438-11	CARBON	56K 5% 1/4W
R556	1-249-441-11	CARBON	100K 5% 1/4W (D590)
R557	1-249-423-11	CARBON	3.3K 5% 1/4W (D590)
R558	1-247-883-00	CARBON	150K 5% 1/4W (D590)
R559	1-249-412-11	CARBON	390 5% 1/4W (D590)
R560	1-249-427-11	CARBON	6.8K 5% 1/4W (D590)
R740	1-247-753-11	CARBON	1.2K 5% 1/2W
R749	1-247-753-11	CARBON	1.2K 5% 1/2W
R790	1-247-753-11	CARBON	1.2K 5% 1/2W
R799	1-247-753-11	CARBON	1.2K 5% 1/2W
R901	1-202-725-00	SOLID	3.3M 10% 1/2W (D390:US, CND/D590:US, CND)
< VARIABLE RESISTOR >			
RV301	1-241-864-11	RES, VAR, CARBON 100K/100K	(INPUT BALANCE) (D590)
RV301	1-241-851-11	RES, VAR, CARBON 100K/100K	(LOUDNESS) (D390)
RV401	1-241-817-11	RES, VAR, CARBON 100K/100K	(BASS)
RV402	1-241-817-11	RES, VAR, CARBON 100K/100K	(TREBLE)
RV403	1-238-965-21	RES, VAR, CARBON 100K/100K	(BALANCE)
RV702	1-241-413-11	RES, VAR, CARBON 100Kx3	(VOLUME) (D590)
RV702	1-241-850-11	RES, VAR, CARBON 100K/100K	(VOLUME) (D390)
< RELAY >			
△RY901	1-515-720-11	RELAY (D390:US, CND, E/D590:US, CND)	
△RY901	1-515-738-11	RELAY, POWER	
< SWITCH >			
S101	1-554-303-21	SWITCH, TACTILE (DIRECT TUNING)	
S102	1-554-303-21	SWITCH, TACTILE (REAR LEVEL +)	(D590)
S103	1-554-303-21	SWITCH, TACTILE (REAR LEVEL -)	(D590)
S104	1-554-303-21	SWITCH, TACTILE (SURROUND ON/OFF)	(D590)

Ref. No.	Part No.	Description	Remark
S105	1-554-303-21	SWITCH, TACTILE (PRESET TUNING -)	
S106	1-554-303-21	SWITCH, TACTILE (TUNING +)	
S107	1-554-303-21	SWITCH, TACTILE (FM)	
S108	1-554-303-21	SWITCH, TACTILE (FM MODE)	
S109	1-554-303-21	SWITCH, TACTILE (PRESET TUNING +)	
S110	1-554-303-21	SWITCH, TACTILE (TUNING -)	
S111	1-554-303-21	SWITCH, TACTILE (AM)	
S113	1-554-303-21	SWITCH, TACTILE (TAPE1/DAT:D390, TAPE/DAT:D590)	
S114	1-554-303-21	SWITCH, TACTILE (TAPE2:D390, VIDEO1:D590)	
S115	1-554-303-21	SWITCH, TACTILE (VIDEO:D390, VIDEO2/LD:D590)	
S117	1-554-303-21	SWITCH, TACTILE (PHONO)	
S118	1-554-303-21	SWITCH, TACTILE (TUNER)	
S119	1-554-303-21	SWITCH, TACTILE (CD)	
S121	1-554-303-21	SWITCH, TACTILE (7)	
S122	1-554-303-21	SWITCH, TACTILE (8)	
S123	1-554-303-21	SWITCH, TACTILE (9)	
S124	1-554-303-21	SWITCH, TACTILE (MEMORY)	
S125	1-554-303-21	SWITCH, TACTILE (4)	
S126	1-554-303-21	SWITCH, TACTILE (5)	
S127	1-554-303-21	SWITCH, TACTILE (6)	
S128	1-554-303-21	SWITCH, TACTILE (0)	
S129	1-554-303-21	SWITCH, TACTILE (1)	
S130	1-554-303-21	SWITCH, TACTILE (2)	
S131	1-554-303-21	SWITCH, TACTILE (3)	
S132	1-554-303-21	SWITCH, TACTILE (SHIFT)	
S133	1-554-303-21	SWITCH, TACTILE (DBFB) (D590)	
S134	1-554-303-21	SWITCH, TACTILE (MUTING) (D590)	
S135	1-554-303-21	SWITCH, TACTILE (DELAY TIME) (D590)	
S136	1-554-303-21	SWITCH, TACTILE (SURROUND MODE) (D590)	
S137	1-554-303-21	SWITCH, TACTILE (POWER ON/STANDBY)	
S701	1-571-854-21	SWITCH, PUSH (2 KEY) (SPEAKERS A/B) (D590)	
S701	1-571-485-11	SWITCH, PUSH (2 KEY) (SPEAKERS A/B) (D390)	
△S901	1-571-437-11	SWITCH, POWER VOLTAGE CHANGE (D390:E)	
< TRANSFORMER >			
△T902	1-450-358-11	TRANSFORMER, POWER (D390:UK, E/D590:UK)	
△T902	1-450-361-11	TRANSFORMER, POWER (D390:US, CND/D590:US, CND)	
< VARISTOR >			
△VZ901	1-807-180-31	VARISTOR SNR-14A471U (D390:UK, E/D590:UK)	
△VZ901	1-807-293-31	VARISTOR SNR-14A221U (D390:US, CND/D590:US, CND)	
< VIBRATOR >			
X101	1-577-101-11	VIBRATOR, CERAMIC (4.19MHz)	

The components identified by mark △ or dotted line with mark. △ are critical for safety. Replace only with part number specified.

Les composants identifiés par une marque △ sont critiques pour la sécurité. Ne les remplacer que par une pièce portant le numéro spécifié.

MAIN

Ref. No.	Part No.	Description	Remark	Ref. No.	Part No.	Description	Remark
*	A-4347-762-A	MAIN BOARD, COMPLETE (D390:US, CND)		C338	1-136-167-00	FILM	0.15uF 5% 50V (D590)
*	A-4347-763-A	MAIN BOARD, COMPLETE (D390:UK, E)		C339	1-102-108-00	CERAMIC	150PF 10% 50V (D590)
*	A-4347-776-A	MAIN BOARD, COMPLETE (D590:US, CND)		C340	1-161-055-00	CERAMIC	0.022uF 10% 50V (D590)
*	A-4347-777-A	MAIN BOARD, COMPLETE (D590:UK)					

	4-812-134-00	RIVET NYLON, 3.5		C341	1-161-039-00	CERAMIC	0.001uF 10% 50V (D590)
*	4-942-204-01	PLATE, GROUND (D390:US, CND/D590:US, CND)		C342	1-124-927-11	ELECT	4.7uF 20% 100V (D590)
	4-953-350-01	PLATE, GROUND		C343	1-162-294-31	CERAMIC	0.001uF 10% 50V (D590)
	7-685-647-79	SCREW +BVTP 3X10 TYPE2 IT-3		C344	1-124-927-11	ELECT	4.7uF 20% 100V (D590)
	7-682-548-04	SCREW +BVTT 3X8 (S)		C345	1-124-927-11	ELECT	4.7uF 20% 100V (D590)
		< CAPACITOR >					
C301	1-124-907-11	ELECT	10uF 20% 50V	C346	1-124-927-11	ELECT	4.7uF 20% 100V (D590)
C302	1-162-215-31	CERAMIC	47PF 5% 50V	C347	1-124-927-11	ELECT	4.7uF 20% 100V (D590)
C303	1-124-907-11	ELECT	10uF 20% 50V	C348	1-124-925-11	ELECT	2.2uF 20% 100V (D590)
C304	1-124-907-11	ELECT	10uF 20% 50V (D590)	C351	1-124-907-11	ELECT	10uF 20% 50V
C305	1-124-907-11	ELECT	10uF 20% 50V (D590)	C352	1-162-215-31	CERAMIC	47PF 5% 50V
C306	1-162-215-31	CERAMIC	47PF 5% 50V (D590)				
C307	1-162-282-31	CERAMIC	100PF 10% 50V (D590)	C353	1-124-907-11	ELECT	10uF 20% 50V
C308	1-124-907-11	ELECT	10uF 20% 50V (D590)	C355	1-124-907-11	ELECT	10uF 20% 50V (D590)
C309	1-124-907-11	ELECT	10uF 20% 50V (D590)	C356	1-162-215-31	CERAMIC	47PF 5% 50V (D590)
C310	1-124-464-11	ELECT	0.22uF 20% 50V (D590)	C357	1-162-282-31	CERAMIC	100PF 10% 50V (D590)
				C358	1-124-907-11	ELECT	10uF 20% 50V (D590)
C311	1-124-472-11	ELECT	470uF 20% 10V (D590)				
C312	1-124-927-11	ELECT	4.7uF 20% 100V (D590)	C359	1-124-907-11	ELECT	10uF 20% 50V (D590)
C313	1-161-039-00	CERAMIC	0.001uF 10% 50V (D590)	C401	1-162-282-31	CERAMIC	100PF 10% 50V
C314	1-161-055-00	CERAMIC	0.022uF 10% 50V (D590)	C402	1-123-382-00	ELECT	3.3uF 20% 100V
C315	1-102-108-00	CERAMIC	150PF 10% 50V (D590)	C403	1-162-282-31	CERAMIC	100PF 10% 50V
				C404	1-162-282-31	CERAMIC	100PF 10% 50V
C316	1-124-120-11	ELECT	220uF 20% 25V (D590)				
C317	1-124-120-11	ELECT	220uF 20% 25V (D590)	C405	1-124-034-51	ELECT	33uF 20% 16V
C318	1-124-477-11	ELECT	47uF 20% 25V (D590)	C406	1-130-480-00	MYLAR	0.0056uF 5% 50V
C319	1-136-165-00	FILM	0.1uF 5% 50V (D590)	C407	1-130-473-00	MYLAR	0.0015uF 5% 50V
C320	1-161-379-00	CERAMIC	0.01uF 20% 25V (D590)	C408	1-123-382-00	ELECT	3.3uF 20% 100V
				C420	1-164-159-11	CERAMIC	0.1uF 50V
C321	1-124-120-11	ELECT	220uF 20% 25V (D590)				
C322	1-164-159-11	CERAMIC	0.1uF 50V (D590)	C422	1-124-478-11	ELECT	100uF 20% 25V
C323	1-162-209-31	CERAMIC	27PF 5% 50V (D590)	C423	1-124-478-11	ELECT	100uF 20% 25V
C324	1-162-209-31	CERAMIC	27PF 5% 50V (D590)	C430	1-162-294-31	CERAMIC	0.001uF 10% 50V
C325	1-124-464-11	ELECT	0.22uF 20% 50V (D590)	C431	1-130-471-00	MYLAR	0.001uF 5% 50V
				C432	1-124-925-11	ELECT	2.2uF 20% 100V (D590)
C326	1-130-481-00	MYLAR	0.0068uF 5% 50V (D590)				
C327	1-130-478-00	MYLAR	0.0039uF 5% 50V (D590)	C433	1-124-925-11	ELECT	2.2uF 20% 100V
C328	1-130-479-00	MYLAR	0.0047uF 5% 50V (D590)	C437	1-124-907-11	ELECT	10uF 20% 50V (D390)
C329	1-130-489-00	MYLAR	0.033uF 5% 50V (D590)	C441	1-124-464-11	ELECT	0.22uF 20% 50V (D590)
C330	1-124-768-11	ELECT	4.7uF 20% 50V (D590)	C451	1-162-282-31	CERAMIC	100PF 10% 50V
				C452	1-123-382-00	ELECT	3.3uF 20% 100V
C331	1-124-903-11	ELECT	1uF 20% 50V (D590)				
C332	1-124-768-11	ELECT	4.7uF 20% 50V (D590)	C453	1-162-282-31	CERAMIC	100PF 10% 50V
C333	1-102-115-00	CERAMIC	560PF 10% 50V (D590)	C454	1-162-282-31	CERAMIC	100PF 10% 50V
C334	1-130-480-00	MYLAR	0.0056uF 5% 50V (D590)	C455	1-124-034-51	ELECT	33uF 20% 16V
C335	1-130-481-00	MYLAR	0.0068uF 5% 50V (D590)	C456	1-130-480-00	MYLAR	0.0056uF 5% 50V
				C457	1-130-473-00	MYLAR	0.0015uF 5% 50V
C336	1-124-907-11	ELECT	10uF 20% 50V (D590)				
C337	1-102-116-00	CERAMIC	680PF 10% 50V (D590)	C458	1-123-382-00	ELECT	3.3uF 20% 100V
				C485	1-162-282-31	CERAMIC	100PF 10% 50V (D390:US, CND)
				C601	1-124-927-11	ELECT	4.7uF 20% 100V (D590)
				C602	1-162-282-31	CERAMIC	100PF 10% 50V (D590)
				C603	1-162-282-31	CERAMIC	100PF 10% 50V (D590)

MAIN

Ref. No.	Part No.	Description	Remark	Ref. No.	Part No.	Description	Remark
D956	8-719-010-29	DIODE UZ-4. 3BSB		Q306	8-729-900-63	TRANSISTOR DTA124ES (D590)	
D962	8-719-010-47	DIODE UZ-6. 2BSC		Q307	8-729-209-15	TRANSISTOR 2SD2012 (D590)	
D963	8-719-933-41	DIODE HZS6C3L		Q309	8-729-141-30	TRANSISTOR 2SC3623A-LK (D590)	
D964	8-719-985-53	DIODE HZS4ALL		Q401	8-729-141-30	TRANSISTOR 2SC3623A-LK (D590)	
D965	8-719-987-63	DIODE 1N4148M		Q402	8-729-141-30	TRANSISTOR 2SC3623A-LK	
D966	8-719-987-63	DIODE 1N4148M		Q403	8-729-141-30	TRANSISTOR 2SC3623A-LK	
D967	8-719-987-63	DIODE 1N4148M		Q406	8-729-900-63	TRANSISTOR DTA124ES	
D968	8-719-987-63	DIODE 1N4148M		Q407	8-729-900-63	TRANSISTOR DTA124ES (D590)	
D969	8-719-987-63	DIODE 1N4148M		Q451	8-729-141-30	TRANSISTOR 2SC3623A-LK (D590)	
D970	8-719-987-63	DIODE 1N4148M		Q452	8-729-141-30	TRANSISTOR 2SC3623A-LK	
D971	8-719-987-63	DIODE 1N4148M		Q453	8-729-141-30	TRANSISTOR 2SC3623A-LK	
D972	8-719-200-77	DIODE 10E2N (D590)		Q602	8-729-119-79	TRANSISTOR 2SC2785-FEK (D590)	
D973	8-719-200-77	DIODE 10E2N (D590)		Q701	8-729-620-18	TRANSISTOR 2SA979-FG	
D974	8-719-200-77	DIODE 10E2N (D590)		Q702	8-729-140-82	TRANSISTOR 2SA988-PAFAEA	
D975	8-719-200-77	DIODE 10E2N (D590)		Q703	8-729-119-78	TRANSISTOR 2SC2785-HFE	
< IC >				Q704	8-729-119-78	TRANSISTOR 2SC2785-HFE	
IC301	8-759-801-01	IC LC4966 (D590)		Q705	8-729-141-06	TRANSISTOR 2SA1142-QPE	
IC302	8-759-823-63	LV1001M (D590)		Q706	8-729-209-15	TRANSISTOR 2SD2012	
IC303	8-759-821-13	IC LM3364K-15 (D590)		Q707	8-729-141-05	TRANSISTOR 2SC2682-QPE	
IC304	8-759-820-11	IC LC7535 (D590)		Q710	8-729-141-46	TRANSISTOR 2SC4431-LK	
IC305	8-759-634-50	IC M5218AL (D590)		Q711	8-729-141-37	TRANSISTOR 2SA1684-LK	
IC306	8-759-634-50	IC M5218AL		Q712	8-729-321-57	TRANSISTOR 2SC4385-OPY-LF (D590)	
IC307	8-759-634-50	IC M5218AL (D590)		Q712	8-729-016-17	TRANSISTOR 2SD2064 (D390)	
IC308	8-759-634-50	IC M5218AL (D590)		Q713	8-729-321-58	TRANSISTOR 2SA1670-OPY-LF (D590)	
IC401	8-759-112-93	IC uPC4570HA-1		Q713	8-729-016-06	TRANSISTOR 2SB1371 (D390)	
IC402	8-759-805-14	IC LC7822		Q714	8-729-140-82	TRANSISTOR 2SA988-PAFAEA	
IC601	8-759-502-31	IC SI18752 (D590)		Q715	8-729-620-05	TRANSISTOR 2SC2603-EF	
< JACK >				Q716	8-729-620-05	TRANSISTOR 2SC2603-EF	
J401	1-695-188-21	JACK, PIN 4P (PHONO/CD)		Q717	8-729-620-05	TRANSISTOR 2SC2603-EF	
J403	1-695-188-21	JACK, PIN 4P (VIDEO1 IN/VIDEO2 IN) (D590)		Q718	8-729-620-05	TRANSISTOR 2SC2603-EF	
J405	1-695-188-21	JACK, PIN 4P (TAPE1 IN/OUT) (D390)		Q751	8-729-620-18	TRANSISTOR 2SA979-FG	
J406	1-695-188-21	JACK, PIN 4P (VIDEO IN/OUT) (D390)		Q752	8-729-140-82	TRANSISTOR 2SA988-PAFAEA	
J407	1-695-188-21	JACK, PIN 4P (TAPE2 IN/OUT) (D390)		Q753	8-729-119-78	TRANSISTOR 2SC2785-HFE	
< COIL >				Q754	8-729-119-78	TRANSISTOR 2SC2785-HFE	
L301	1-410-521-11	INDUCTOR 100uH (D590)		Q755	8-729-141-06	TRANSISTOR 2SA1142-QPE	
L601	1-420-872-00	COIL, AIR CORE (D590)		Q756	8-729-209-15	TRANSISTOR 2SD2012	
L701	1-420-872-00	COIL, AIR CORE		Q757	8-729-119-76	TRANSISTOR 2SA1175-HFE	
L751	1-420-872-00	COIL, AIR CORE		Q760	8-729-141-46	TRANSISTOR 2SC4431-LK	
< TRANSISTOR >				Q761	8-729-141-37	TRANSISTOR 2SA1684-LK	
Q301	8-729-900-36	TRANSISTOR DTC124ES (D590)		Q762	8-729-321-57	TRANSISTOR 2SC4385-OPY-LF (D590)	
Q302	8-729-900-63	TRANSISTOR DTA124ES (D590)		Q762	8-729-016-07	TRANSISTOR 2SD2064 (D390)	
Q303	8-729-900-36	TRANSISTOR DTC124ES (D590)		Q763	8-729-321-58	TRANSISTOR 2SA1670-OPY-LF (D590)	
Q304	8-729-900-36	TRANSISTOR DTC124ES (D590)		Q763	8-729-016-06	TRANSISTOR 2SB1371 (D390)	
Q305	8-729-900-36	TRANSISTOR DTC124ES (D590)		Q764	8-729-140-82	TRANSISTOR 2SA988-PAFAEA	
Q401	8-729-141-30	TRANSISTOR 2SC3623A-LK (D590)		Q951	8-729-209-15	TRANSISTOR 2SD2012	
Q402	8-729-141-30	TRANSISTOR 2SC3623A-LK		Q952	8-729-140-97	TRANSISTOR 2SB734-34	
Q403	8-729-141-30	TRANSISTOR 2SC3623A-LK		Q953	8-729-180-92	TRANSISTOR 2SD809-K	
Q406	8-729-900-63	TRANSISTOR DTA124ES		Q954	8-729-620-05	TRANSISTOR 2SC2603-EF	
Q407	8-729-900-63	TRANSISTOR DTA124ES (D590)		Q955	8-729-119-76	TRANSISTOR 2SA1175-HFE	
Q451	8-729-141-30	TRANSISTOR 2SC3623A-LK (D590)					
Q452	8-729-141-30	TRANSISTOR 2SC3623A-LK					
Q453	8-729-141-30	TRANSISTOR 2SC3623A-LK					
Q602	8-729-119-79	TRANSISTOR 2SC2785-FEK (D590)					
Q701	8-729-620-18	TRANSISTOR 2SA979-FG					
Q702	8-729-140-82	TRANSISTOR 2SA988-PAFAEA					
Q703	8-729-119-78	TRANSISTOR 2SC2785-HFE					
Q704	8-729-119-78	TRANSISTOR 2SC2785-HFE					
Q705	8-729-141-06	TRANSISTOR 2SA1142-QPE					
Q706	8-729-209-15	TRANSISTOR 2SD2012					
Q707	8-729-141-05	TRANSISTOR 2SC2682-QPE					
Q710	8-729-141-46	TRANSISTOR 2SC4431-LK					
Q711	8-729-141-37	TRANSISTOR 2SA1684-LK					
Q712	8-729-321-57	TRANSISTOR 2SC4385-OPY-LF (D590)					
Q712	8-729-016-17	TRANSISTOR 2SD2064 (D390)					
Q713	8-729-321-58	TRANSISTOR 2SA1670-OPY-LF (D590)					
Q713	8-729-016-06	TRANSISTOR 2SB1371 (D390)					
Q714	8-729-140-82	TRANSISTOR 2SA988-PAFAEA					
Q715	8-729-620-05	TRANSISTOR 2SC2603-EF					
Q716	8-729-620-05	TRANSISTOR 2SC2603-EF					
Q717	8-729-620-05	TRANSISTOR 2SC2603-EF					
Q718	8-729-620-05	TRANSISTOR 2SC2603-EF					
Q751	8-729-620-18	TRANSISTOR 2SA979-FG					
Q752	8-729-140-82	TRANSISTOR 2SA988-PAFAEA					
Q753	8-729-119-78	TRANSISTOR 2SC2785-HFE					
Q754	8-729-119-78	TRANSISTOR 2SC2785-HFE					
Q755	8-729-141-06	TRANSISTOR 2SA1142-QPE					
Q756	8-729-209-15	TRANSISTOR 2SD2012					
Q757	8-729-119-76	TRANSISTOR 2SA1175-HFE					
Q760	8-729-141-46	TRANSISTOR 2SC4431-LK					
Q761	8-729-141-37	TRANSISTOR 2SA1684-LK					
Q762	8-729-321-57	TRANSISTOR 2SC4385-OPY-LF (D590)					
Q762	8-729-016-07	TRANSISTOR 2SD2064 (D390)					
Q763	8-729-321-58	TRANSISTOR 2SA1670-OPY-LF (D590)					
Q763	8-729-016-06	TRANSISTOR 2SB1371 (D390)					
Q764	8-729-140-82	TRANSISTOR 2SA988-PAFAEA					
Q951	8-729-209-15	TRANSISTOR 2SD2012					
Q952	8-729-140-97	TRANSISTOR 2SB734-34					
Q953	8-729-180-92	TRANSISTOR 2SD809-K					
Q954	8-729-620-05	TRANSISTOR 2SC2603-EF					
Q955	8-729-119-76	TRANSISTOR 2SA1175-HFE					

Ref. No.	Part No.	Description	Remark
Q956	8-729-119-76	TRANSISTOR 2SA1175-HFE	
Q957	8-729-620-05	TRANSISTOR 2SC2603-EF	
Q958	8-729-900-36	TRANSISTOR DTC124ES	
Q959	8-729-904-39	TRANSISTOR DTC114TS	
Q960	8-729-620-05	TRANSISTOR 2SC2603-EF	
< RESISTOR >			
R302	1-247-887-00	CARBON 220K 5%	1/4W
R303	1-247-887-00	CARBON 220K 5%	1/4W
R304	1-249-417-11	CARBON 1K 5%	1/4W (D590)
R304	1-249-416-11	CARBON 820 5%	1/4W (D390)
R305	1-249-429-11	CARBON 10K 5%	1/4W (D590)
R306	1-247-887-00	CARBON 220K 5%	1/4W (D590)
R307	1-249-429-11	CARBON 10K 5%	1/4W (D590)
R308	1-249-429-11	CARBON 10K 5%	1/4W (D590)
R309	1-249-429-11	CARBON 10K 5%	1/4W (D590)
R310	1-249-429-11	CARBON 10K 5%	1/4W (D590)
R311	1-247-895-00	CARBON 470K 5%	1/4W (D590)
R312	1-249-429-11	CARBON 10K 5%	1/4W (D590)
R313	1-249-429-11	CARBON 10K 5%	1/4W (D590)
R314	1-249-437-11	CARBON 47K 5%	1/4W (D590)
R315	1-249-437-11	CARBON 47K 5%	1/4W (D590)
R316	1-249-428-11	CARBON 8.2K 5%	1/4W (D590)
R317	1-249-423-11	CARBON 3.3K 5%	1/4W (D590)
R318	1-249-425-11	CARBON 4.7K 5%	1/4W (D590)
R319	1-249-430-11	CARBON 12K 5%	1/4W (D590)
R320	1-247-903-00	CARBON 1M 5%	1/4W (D590)
R321	1-249-405-11	CARBON 100 5%	1/4W (D590)
R322	1-249-437-11	CARBON 47K 5%	1/4W (D590)
R323	1-249-431-11	CARBON 15K 5%	1/4W (D590)
R324	1-249-428-11	CARBON 8.2K 5%	1/4W (D590)
R325	1-249-423-11	CARBON 3.3K 5%	1/4W (D590)
R326	1-249-428-11	CARBON 8.2K 5%	1/4W (D590)
R327	1-249-428-11	CARBON 8.2K 5%	1/4W (D590)
R328	1-249-436-11	CARBON 39K 5%	1/4W (D590)
R332	1-247-887-00	CARBON 220K 5%	1/4W (D590)
R333	1-249-426-11	CARBON 5.6K 5%	1/4W (D590)
R334	1-249-435-11	CARBON 33K 5%	1/4W (D590)
R335	1-247-887-00	CARBON 220K 5%	1/4W (D590)
R336	1-247-887-00	CARBON 220K 5%	1/4W (D590)
R337	1-249-417-11	CARBON 1K 5%	1/4W (D590)
R352	1-247-887-00	CARBON 220K 5%	1/4W
R353	1-247-887-00	CARBON 220K 5%	1/4W
R354	1-249-417-11	CARBON 1K 5%	1/4W (D590)
R354	1-249-416-11	CARBON 820 5%	1/4W (D390)
R355	1-249-429-11	CARBON 10K 5%	1/4W (D590)
R361	1-247-895-00	CARBON 470K 5%	1/4W (D590)
R362	1-249-429-11	CARBON 10K 5%	1/4W (D590)

Ref. No.	Part No.	Description	Remark
R363	1-249-429-11	CARBON 10K 5%	1/4W (D590)
R387	1-249-417-11	CARBON 1K 5%	1/4W (D590)
R401	1-249-411-11	CARBON 330 5%	1/4W
△R402	1-249-409-11	CARBON 220 5%	1/4W
R403	1-249-417-11	CARBON 1K 5%	1/4W (D390:UK, E, D590)
R404	1-249-425-11	CARBON 4.7K 5%	1/4W
△R405	1-249-409-11	CARBON 220 5%	1/4W
R405	1-249-417-11	CARBON 1K 5%	1/4W (D390:US, CND)
△R406	1-249-409-11	CARBON 220 5%	1/4W (D590)
R407	1-249-425-11	CARBON 4.7K 5%	1/4W
R413	1-249-437-11	CARBON 47K 5%	1/4W
R414	1-247-897-11	CARBON 560K 5%	1/4W
R415	1-249-416-11	CARBON 820 5%	1/4W
R416	1-247-897-11	CARBON 560K 5%	1/4W
R417	1-249-437-11	CARBON 47K 5%	1/4W
R418	1-249-417-11	CARBON 1K 5%	1/4W
R419	1-247-897-11	CARBON 560K 5%	1/4W
R420	1-249-417-11	CARBON 1K 5%	1/4W
R421	1-247-838-00	CARBON 2K 5%	1/4W (D590)
R421	1-249-408-11	CARBON 180 5%	1/4W (D390)
R422	1-249-405-11	CARBON 100 5%	1/4W (D590)
R423	1-249-441-11	CARBON 100K 5%	1/4W (D590)
R424	1-249-422-11	CARBON 2.7K 5%	1/4W (D590)
R425	1-249-425-11	CARBON 4.7K 5%	1/4W
R426	1-249-437-11	CARBON 47K 5%	1/4W
R427	1-249-437-11	CARBON 47K 5%	1/4W
R428	1-249-425-11	CARBON 4.7K 5%	1/4W
R429	1-249-437-11	CARBON 47K 5%	1/4W
R430	1-249-437-11	CARBON 47K 5%	1/4W
R431	1-249-425-11	CARBON 4.7K 5%	1/4W (D390)
R432	1-247-883-00	CARBON 150K 5%	1/4W
R433	1-247-883-00	CARBON 150K 5%	1/4W
R434	1-249-425-11	CARBON 4.7K 5%	1/4W
R435	1-247-883-00	CARBON 150K 5%	1/4W (D590)
R436	1-249-417-11	CARBON 1K 5%	1/4W (D390)
R437	1-249-437-11	CARBON 47K 5%	1/4W
R438	1-249-437-11	CARBON 47K 5%	1/4W (D590:UK)
R438	1-249-429-11	CARBON 10K 5%	1/4W
R439	1-249-437-11	CARBON 47K 5%	1/4W
R440	1-249-437-11	CARBON 47K 5%	1/4W
R441	1-249-413-11	CARBON 470 5%	1/4W
R442	1-249-437-11	CARBON 47K 5%	1/4W
R444	1-249-437-11	CARBON 47K 5%	1/4W
R446	1-249-412-11	CARBON 390 5%	1/4W (D390)
R451	1-249-411-11	CARBON 330 5%	1/4W
△R452	1-249-409-11	CARBON 220 5%	1/4W
R453	1-249-417-11	CARBON 1K 5%	1/4W (D390:UK, E, D590)
R454	1-249-425-11	CARBON 4.7K 5%	1/4W
△R455	1-249-409-11	CARBON 220 5%	1/4W

The components identified by mark △ or dotted line with mark △ are critical for safety. Replace only with part number specified.

Les composants identifiés par une marque △ sont critiques pour la sécurité. Ne les remplacer que par une pièce portant le numéro spécifié.

MAIN

Ref. No.	Part No.	Description	Remark
R455	1-249-417-11	CARBON 1K 5% 1/4W	(D390:US, CND)
<u>△</u> R456	1-249-409-11	CARBON 220 5% 1/4W	(D590)
R457	1-249-425-11	CARBON 4.7K 5% 1/4W	
R463	1-249-437-11	CARBON 47K 5% 1/4W	
R464	1-247-897-11	CARBON 560K 5% 1/4W	
R465	1-249-416-11	CARBON 820 5% 1/4W	
R466	1-247-897-11	CARBON 560K 5% 1/4W	
R467	1-249-437-11	CARBON 47K 5% 1/4W	
R468	1-249-417-11	CARBON 1K 5% 1/4W	
R469	1-247-897-11	CARBON 560K 5% 1/4W	
R470	1-249-417-11	CARBON 1K 5% 1/4W	
R471	1-247-838-00	CARBON 2K 5% 1/4W	(D590)
R471	1-249-408-11	CARBON 180 5% 1/4W	(D390)
R472	1-249-405-11	CARBON 100 5% 1/4W	(D590)
R481	1-249-425-11	CARBON 4.7K 5% 1/4W	(D390)
R486	1-249-417-11	CARBON 1K 5% 1/4W	(D390)
R601	1-249-417-11	CARBON 1K 5% 1/4W	(D590)
R602	1-249-439-11	CARBON 68K 5% 1/4W	(D590)
R603	1-249-417-11	CARBON 1K 5% 1/4W	(D590)
R604	1-249-439-11	CARBON 68K 5% 1/4W	(D590)
<u>△</u> R607	1-217-151-00	RES, METAL PLATE	0.22 (D590)
<u>△</u> R608	1-249-393-11	CARBON 10 5% 1/4W	(D590)
<u>△</u> R609	1-249-393-11	CARBON 10 5% 1/4W	(D590)
<u>△</u> R610	1-249-393-11	CARBON 10 5% 1/4W	(D590)
R611	1-249-441-11	CARBON 100K 5% 1/4W	(D590)
R612	1-249-429-11	CARBON 10K 5% 1/4W	(D590)
R613	1-249-441-11	CARBON 100K 5% 1/4W	(D590)
R614	1-249-435-11	CARBON 33K 5% 1/4W	(D590)
R614	1-247-891-00	CARBON 330K 5% 1/4W	(D390)
R615	1-247-808-11	CARBON 110 5% 1/4W	(D590)
R616	1-247-808-11	CARBON 110 5% 1/4W	(D590)
R701	1-249-417-11	CARBON 1K 5% 1/4W	
R702	1-249-434-11	CARBON 27K 5% 1/4W	
R703	1-249-435-11	CARBON 33K 5% 1/4W	
R704	1-249-421-11	CARBON 2.2K 5% 1/4W	
R705	1-249-426-11	CARBON 5.6K 5% 1/4W	
R706	1-249-414-11	CARBON 560 5% 1/4W	
R707	1-249-423-11	CARBON 3.3K 5% 1/4W	
R708	1-249-411-11	CARBON 330 5% 1/4W	
<u>△</u> R709	1-249-409-11	CARBON 220 5% 1/4W	
<u>△</u> R710	1-249-409-11	CARBON 220 5% 1/4W	
<u>△</u> R711	1-249-409-11	CARBON 220 5% 1/4W	
R712	1-249-435-11	CARBON 33K 5% 1/4W	
<u>△</u> R713	1-249-397-11	CARBON 22 5% 1/4W	
R714	1-249-427-11	CARBON 6.8K 5% 1/4W	
R715	1-249-406-11	CARBON 120 5% 1/4W	
<u>△</u> R716	1-249-397-11	CARBON 22 5% 1/4W	
<u>△</u> R717	1-249-393-11	CARBON 10 5% 1/4W	
<u>△</u> R718	1-249-393-11	CARBON 10 5% 1/4W	

Ref. No.	Part No.	Description	Remark
<u>△</u> R719	1-249-393-11	CARBON 10 5% 1/4W	(D390:UK, E)
<u>△</u> R720	1-249-393-11	CARBON 10 5% 1/4W	(D390:UK, E)
<u>△</u> R723	1-247-745-11	CARBON 330 5% 1/2W	
<u>△</u> R724	1-249-393-11	CARBON 10 5% 1/4W	
<u>△</u> R725	1-249-393-11	CARBON 10 5% 1/4W	
<u>△</u> R726	1-217-611-00	RES, METAL PLATE	0.1
<u>△</u> R727	1-217-611-00	RES, METAL PLATE	0.1
R728	1-249-417-11	CARBON 1K 5% 1/4W	
R729	1-249-431-11	CARBON 15K 5% 1/4W	
R730	1-249-435-11	CARBON 33K 5% 1/4W	(D590)
R730	1-249-429-11	CARBON 10K 5% 1/4W	
R731	1-249-441-11	CARBON 100K 5% 1/4W	
R732	1-249-417-11	CARBON 1K 5% 1/4W	
R733	1-249-435-11	CARBON 33K 5% 1/4W	
R734	1-249-427-11	CARBON 6.8K 5% 1/4W	
<u>△</u> R735	1-249-397-11	CARBON 22 5% 1/4W	
<u>△</u> R736	1-249-397-11	CARBON 22 5% 1/4W	
<u>△</u> R737	1-249-393-11	CARBON 10 5% 1/4W	
<u>△</u> R738	1-249-393-11	CARBON 10 5% 1/4W	
R739	1-247-808-11	CARBON 110 5% 1/4W	(D590)
R739	1-249-410-11	CARBON 270 5% 1/4W	(D390)
R741	1-249-441-11	CARBON 100K 5% 1/4W	(D590)
R742	1-249-427-11	CARBON 6.8K 5% 1/4W	(D590)
R743	1-249-441-11	CARBON 100K 5% 1/4W	
R744	1-249-429-11	CARBON 10K 5% 1/4W	
R745	1-249-399-11	CARBON 33 5% 1/4W	
R751	1-249-417-11	CARBON 1K 5% 1/4W	
R752	1-249-434-11	CARBON 27K 5% 1/4W	
R753	1-249-435-11	CARBON 33K 5% 1/4W	
R754	1-249-421-11	CARBON 2.2K 5% 1/4W	
R755	1-249-426-11	CARBON 5.6K 5% 1/4W	
R756	1-249-414-11	CARBON 560 5% 1/4W	
R757	1-249-423-11	CARBON 3.3K 5% 1/4W	
R758	1-249-411-11	CARBON 330 5% 1/4W	
<u>△</u> R759	1-249-409-11	CARBON 220 5% 1/4W	
<u>△</u> R760	1-249-409-11	CARBON 220 5% 1/4W	
<u>△</u> R761	1-249-409-11	CARBON 220 5% 1/4W	
R762	1-249-435-11	CARBON 33K 5% 1/4W	
<u>△</u> R763	1-249-397-11	CARBON 22 5% 1/4W	
R764	1-249-427-11	CARBON 6.8K 5% 1/4W	
R765	1-249-406-11	CARBON 120 5% 1/4W	
<u>△</u> R766	1-249-397-11	CARBON 22 5% 1/4W	
<u>△</u> R767	1-249-393-11	CARBON 10 5% 1/4W	
<u>△</u> R768	1-249-393-11	CARBON 10 5% 1/4W	
<u>△</u> R773	1-247-745-11	CARBON 330 5% 1/2W	
<u>△</u> R774	1-249-393-11	CARBON 10 5% 1/4W	
<u>△</u> R775	1-249-393-11	CARBON 10 5% 1/4W	
<u>△</u> R776	1-217-611-00	RES, METAL PLATE	0.1

The components identified by mark △ or dotted line with mark △ are critical for safety. Replace only with part number specified.

Les composants identifiés par une marque △ sont critiques pour la sécurité. Ne les remplacer que par une pièce portant le numéro spécifié.

MAIN	TUNER
------	-------

Ref. No.	Part No.	Description	Remark
△R777	1-217-611-00	RES, METAL PLATE	0.1
R778	1-249-417-11	CARBON	1K 5% 1/4W
R779	1-249-431-11	CARBON	15K 5% 1/4W
R780	1-249-435-11	CARBON	33K 5% 1/4W (D590)
R781	1-249-440-11	CARBON	82K 5% 1/4W
R783	1-249-417-11	CARBON	1K 5% 1/4W
△R785	1-249-397-11	CARBON	22 5% 1/4W
△R786	1-249-397-11	CARBON	22 5% 1/4W
△R787	1-249-393-11	CARBON	10 5% 1/4W
△R788	1-249-393-11	CARBON	10 5% 1/4W
R799	1-247-808-11	CARBON	110 5% 1/4W (D590)
R799	1-249-410-11	CARBON	270 5% 1/4W (D390)
R801	1-249-412-11	CARBON	390 5% 1/4W
R803	1-249-414-11	CARBON	560 5% 1/4W (D590)
R804	1-247-895-00	CARBON	470K 5% 1/4W (D390)
R851	1-249-412-11	CARBON	390 5% 1/4W
R854	1-247-895-00	CARBON	470K 5% 1/4W (D390)
△R952	1-215-889-00	METAL OXIDE	330 5% 2W F (D590)
R952	1-247-743-11	CARBON	20 5% 1/2W F (D390)
R953	1-249-422-11	CARBON	2.7K 5% 1/4W
R954	1-249-423-11	CARBON	3.3K 5% 1/4W
△R955	1-216-446-00	METAL OXIDE	18 5% 2W F (D590)
△R955	1-216-448-11	METAL OXIDE	39 5% 2W F (D390)
R956	1-249-405-11	CARBON	100 5% 1/4W
△R957	1-249-409-11	CARBON	220 5% 1/4W
△R958	1-249-409-11	CARBON	220 5% 1/4W
R959	1-249-441-11	CARBON	100K 5% 1/4W
R960	1-249-429-11	CARBON	10K 5% 1/4W
△R963	1-249-395-11	CARBON	15 5% 1/4W
R964	1-249-423-11	CARBON	3.3K 5% 1/4W
R965	1-249-437-11	CARBON	47K 5% 1/4W
R966	1-249-429-11	CARBON	10K 5% 1/4W
R967	1-249-429-11	CARBON	10K 5% 1/4W
R968	1-249-417-11	CARBON	1K 5% 1/4W
R969	1-249-429-11	CARBON	10K 5% 1/4W
R970	1-249-426-11	CARBON	5.6K 5% 1/4W
R971	1-249-417-11	CARBON	1K 5% 1/4W
R972	1-249-426-11	CARBON	5.6K 5% 1/4W
R973	1-249-416-11	CARBON	820 5% 1/4W
R974	1-249-425-11	CARBON	4.7K 5% 1/4W
R975	1-249-437-11	CARBON	47K 5% 1/4W
R976	1-249-396-11	CARBON	18 5% 1/6W (D390)
< RELAY >			
RY401	1-515-614-11	RELAY (D390)	
RY601	1-515-626-11	RELAY (D590)	
RY701	1-515-533-11	RELAY (D390)	
RY701	1-515-626-11	RELAY (D590)	

Ref. No.	Part No.	Description	Remark
< TERMINAL >			
TM601	1-537-240-11	TERMINAL BOARD (CHECKER PIN)	(D590)
TM701	1-537-376-11	TERMINAL BOARD (SP)	
< TEST PIN >			
* TP1	1-560-060-00	PIN, CONNECTOR 2P	
* TP2	1-560-060-00	PIN, CONNECTOR 2P	
< VIBRATOR >			
X301	1-567-132-00	OSCILLATOR, CERAMIC	8.00MHz (D590)

A-4356-360-A TUNER BOARD, COMPLETE (D390:US, CND/D590:US, CND)			
A-4356-361-A TUNER BOARD, COMPLETE (UK)			
*	A-4347-775-A TUNER BOARD, COMPLETE (D390:E)		

< CAPACITOR >			
C1	1-163-141-00	CERAMIC CHIP	0.001uF 5% 50V
C2	1-124-477-11	ELECT	47uF 20% 25V
C3	1-164-232-11	CERAMIC CHIP	0.01uF 50V
C4	1-163-141-00	CERAMIC CHIP	0.001uF 5% 50V
C5	1-164-232-11	CERAMIC CHIP	0.01uF 50V
C10	1-163-037-11	CERAMIC CHIP	0.022uF 10% 25V
C21	1-161-021-11	CERAMIC	0.047uF 10% 25V
C22	1-164-232-11	CERAMIC CHIP	0.01uF 50V
C23	1-124-477-11	ELECT	47uF 20% 25V
C24	1-123-382-00	ELECT	3.3uF 20% 100V
C25	1-164-232-11	CERAMIC CHIP	0.01uF 50V
C26	1-163-019-00	CERAMIC CHIP	0.0068uF 10% 50V
C27	1-163-117-00	CERAMIC CHIP	100PF 5% 50V
C28	1-124-903-11	ELECT	1uF 20% 50V
C30	1-124-903-11	ELECT	1uF 20% 50V
C31	1-124-902-00	ELECT	0.47uF 20% 50V
C32	1-124-463-00	ELECT	0.1uF 20% 50V
C33	1-130-481-00	MYLAR	0.0068uF 5% 50V (D390:UK/D590:UK)
C33	1-130-482-00	MYLAR	0.0082uF 5% 50V (D390:US, CND, E/D590:US, CND)
C34	1-123-382-00	ELECT	3.3uF 20% 100V
C35	1-130-481-00	MYLAR	0.0068uF 5% 50V (D390:UK/D590:UK)
C35	1-130-482-00	MYLAR	0.0082uF 5% 50V (D390:US, CND, E/D590:US, CND)
C36	1-123-382-00	ELECT	3.3uF 20% 100V
C37	1-124-907-11	ELECT	10uF 20% 50V
C39	1-164-232-11	CERAMIC CHIP	0.01uF 50V
C40	1-124-463-00	ELECT	0.1uF 20% 50V
C41	1-124-927-11	ELECT	4.7uF 20% 100V

The components identified by mark △ or dotted line with mark △ are critical for safety. Replace only with part number specified.

Les composants identifiés par une marque △ sont critiques pour la sécurité. Ne les remplacer que par une pièce portant le numéro spécifié.

TUNER

Ref. No.	Part No.	Description	Remark
C42	1-164-232-11	CERAMIC CHIP 0.01uF	50V
C43	1-126-176-11	ELECT 220uF	20% 10V
C44	1-164-232-11	CERAMIC CHIP 0.01uF	50V
C45	1-123-382-00	ELECT 3.3uF	20% 100V
C46	1-164-161-11	CERAMIC CHIP 0.0022uF	10% 100V
C48	1-123-382-00	ELECT 3.3uF	20% 100V
C49	1-164-161-11	CERAMIC CHIP 0.0022uF	10% 100V
C51	1-124-477-11	ELECT 47uF	20% 25V
C61	1-163-037-11	CERAMIC CHIP 0.022uF	10% 25V
C62	1-163-037-11	CERAMIC CHIP 0.022uF	10% 25V
C63	1-163-037-11	CERAMIC CHIP 0.022uF	10% 25V
C64	1-163-037-11	CERAMIC CHIP 0.022uF	10% 25V
C81	1-102-961-00	CERAMIC 27PF	5% 50V
C82	1-102-961-00	CERAMIC 27PF	5% 50V
C83	1-164-232-11	CERAMIC CHIP 0.01uF	50V
C84	1-164-232-11	CERAMIC CHIP 0.01uF	50V
C85	1-164-232-11	CERAMIC CHIP 0.01uF	50V
C86	1-124-477-11	ELECT 47uF	20% 25V
C87	1-164-232-11	CERAMIC CHIP 0.01uF	50V
C101	1-124-925-11	ELECT 2.2uF	20% 100V
C102	1-124-463-00	ELECT 0.1uF	20% 50V
C104	1-164-232-11	CERAMIC CHIP 0.01uF	50V
C105	1-124-477-11	ELECT 47uF	20% 25V
< FILTER >			
CF1	1-567-389-11	FILTER, CERAMIC	
CF2	1-567-389-11	FILTER, CERAMIC	
CF21	1-577-075-11	OSCILLATOR, CERAMIC	
< COMPOSITION CIRCUIT BLOCK >			
CFT21	1-404-853-11	TRANSFORMER, IF (CERAMIC FILTER)	
< CONNECTOR >			
* CN1	1-565-483-11	CONNECTOR, BOARD TO BOARD 7P (D390:E)	
* CN2	1-565-486-11	CONNECTOR, BOARD TO BOARD 10P (D390:E)	
< JACK >			
* CNJ1	1-565-486-11	CONNECTOR, BOARD TO BOARD 10P (D390:US, CND, UK/D590:US, CND, UK)	
* CNJ2	1-565-483-11	CONNECTOR, BOARD TO BOARD 7P (D390:US, CND, UK/D590:US, CND, UK)	
< FRONTEND >			
FE1	1-465-006-11	FRONT END (FM) (2 GANG)	
FE61	1-236-461-11	ENCAPSULATED COMPONENT	
< IC >			
IC21	8-759-821-45	IC LA1851N	

Ref. No.	Part No.	Description	Remark
IC81	8-759-820-91	IC LC7218	
< COIL >			
L21	1-410-494-11	INDUCTOR 1MMH	
< FILTER >			
LPF21	1-235-164-00	FILTER, LOW PASS	
LPF22	1-235-164-00	FILTER, LOW PASS	
< TRANSISTOR >			
Q1	8-729-230-XX	TRANSISTOR 2SC2669-OY	
Q21	8-729-119-78	TRANSISTOR 2SC2785-HFE	
Q22	8-729-119-78	TRANSISTOR 2SC2785-HFE	
Q23	8-729-900-61	TRANSISTOR DTA114ES	
Q24	8-729-900-80	TRANSISTOR DTC114ES	
Q25	8-729-900-80	TRANSISTOR DTC114ES (D390:E)	
Q81	8-729-900-61	TRANSISTOR DTA114ES	
Q82	8-729-900-80	TRANSISTOR DTC114ES	
Q83	8-729-202-67	TRANSISTOR 2SK246-GR3	
Q84	8-729-230-93	TRANSISTOR 2SC3113-AB	
< RESISTOR >			
△R1	1-249-409-11	CARBON 220 5% 1/4W	
R4	1-216-013-00	METAL CHIP 33 5% 1/10W	
R5	1-216-013-00	METAL CHIP 33 5% 1/10W	
R6	1-216-037-00	METAL CHIP 330 5% 1/10W	
R7	1-216-109-00	METAL CHIP 330K 5% 1/10W	
R21	1-249-404-00	CARBON 82 5% 1/4W	
R22	1-249-462-11	CARBON 22K 5% 1/4W (D390:UK, E/D590:UK)	
R22	1-247-724-11	CARBON 8.2K 5% 1/4W (D390:US, CND/D590:US, CND)	
R23	1-216-049-00	METAL CHIP 1K 5% 1/10W	
R24	1-216-085-00	METAL CHIP 33K 5% 1/10W	
R25	1-216-071-00	METAL CHIP 8.2K 5% 1/10W	
R27	1-249-461-11	CARBON 18K 5% 1/4W	
R28	1-247-719-11	CARBON 3.3K 5% 1/4W	
R29	1-216-073-00	METAL CHIP 10K 5% 1/10W	
R31	1-216-041-00	METAL CHIP 470 5% 1/10W	
R32	1-216-073-00	METAL CHIP 10K 5% 1/10W	
R33	1-216-073-00	METAL CHIP 10K 5% 1/10W	
R35	1-216-089-00	METAL CHIP 47K 5% 1/10W	
R36	1-216-073-00	METAL CHIP 10K 5% 1/10W	
R37	1-216-109-00	METAL CHIP 330K 5% 1/10W	
R39	1-216-057-00	METAL CHIP 2.2K 5% 1/10W	
R40	1-216-055-00	METAL CHIP 1.8K 5% 1/10W	
R41	1-216-067-00	METAL CHIP 5.6K 5% 1/10W	
R42	1-216-109-00	METAL CHIP 330K 5% 1/10W	
R44	1-216-057-00	METAL CHIP 2.2K 5% 1/10W	

The components identified by mark △ or dotted line with mark. △ are critical for safety. Replace only with part number specified.

Les composants identifiés par une marque △ sont critiques pour la sécurité. Ne les remplacer que par une pièce portant le numéro spécifié.

TUNER

Ref. No.	Part No.	Description	Remark		
R45	1-216-055-00	METAL CHIP	1.8K	5%	1/10W
R46	1-216-067-00	METAL CHIP	5.6K	5%	1/10W
△R47	1-249-409-11	CARBON	220	5%	1/4W
R61	1-216-097-00	METAL CHIP	100K	5%	1/10W
R62	1-216-089-00	METAL CHIP	47K	5%	1/10W
R63	1-216-009-00	METAL CHIP	22	5%	1/10W
R81	1-216-049-00	METAL CHIP	1K	5%	1/10W
R82	1-216-049-00	METAL CHIP	1K	5%	1/10W
R83	1-216-049-00	METAL CHIP	1K	5%	1/10W
R84	1-216-049-00	METAL CHIP	1K	5%	1/10W
R85	1-216-073-00	METAL CHIP	10K	5%	1/10W
R86	1-216-049-00	METAL CHIP	1K	5%	1/10W
R87	1-216-073-00	METAL CHIP	10K	5%	1/10W
R88	1-216-065-00	METAL CHIP	4.7K	5%	1/10W
R89	1-216-049-00	METAL CHIP	1K	5%	1/10W
R90	1-216-073-00	METAL CHIP	10K	5%	1/10W
R91	1-216-049-00	METAL CHIP	1K	5%	1/10W
R92	1-249-401-11	CARBON	47	5%	1/4W
R101	1-216-061-00	METAL CHIP	3.3K	5%	1/10W
R102	1-216-043-00	METAL CHIP	560	5%	1/10W
R103	1-216-049-00	METAL CHIP	1K	5%	1/10W
R104	1-216-035-00	METAL CHIP	270	5%	1/10W
R105	1-216-065-00	METAL CHIP	4.7K	5%	1/10W
R106	1-216-057-00	METAL CHIP	2.2K	5%	1/10W
R107	1-216-065-00	METAL CHIP	4.7K	5%	1/10W
R108	1-216-025-00	METAL CHIP	100	5%	1/10W
R109	1-216-065-00	METAL CHIP	4.7K	5%	1/10W
R110	1-249-405-11	CARBON	100	5%	1/4W
< VARIABLE RESISTOR >					
RV21	1-238-015-11	RES, ADJ, CARBON 4.7K			
RV21	1-238-599-11	RES, ADJ, CARBON 4.7K			
RV23	1-238-021-11	RES, ADJ, CARBON 220K (D390:UK, E/D590:UK)			
RV23	1-238-604-11	RES, ADJ, CARBON 220K (D390:UK, E/D590:UK)			
RV24	1-238-017-11	RES, ADJ, CARBON 22K			
RV24	1-238-601-11	RES, ADJ, CARBON 22K			
< TRANSFORMER >					
T21	1-404-807-11	TRANSFORMER, DISCRIMINATOR			
< TERMINAL >					
* TM1	1-537-288-11	TERMINAL BOARD, ANTENNA (PAL) (D390:UK/D590:UK)			
* TM1	1-537-264-11	TERMINAL BOARD (D390:US, CND, E/D590:US, CND)			

Ref. No.	Part No.	Description	Remark
		< TEST PIN >	
* TP1	1-560-060-00	PIN, CONNECTOR 2P	
		< VIBRATOR >	
XT81	1-577-126-11	VIBRATOR, CRYSTAL (7.2MHz)	

MISCELLANEOUS *****			
63	1-696-457-11	WIRE (FLAT TYPE) (5 CORE) (D590)	
64	1-696-456-11	WIRE (FLAT TYPE) (31 CORE)	
△69	1-575-652-11	CORD, POWER (D390:UK/D590:UK)	
△69	1-575-653-11	CORD, POWER (D390:E)	
△69	1-690-609-11	CORD, POWER (D390:US, CND/D590:US, CND)	
△70	1-526-565-00	AC PLUG ADAPTOR (D390:E)	
△CNJ917	1-526-751-00	OUTLET, AC (D390:UK/D590:UK)	
△F901	1-532-286-00	FUSE, TIME LAG (T2.5AL) (D390:UK, E/D590:UK)	
△F901	1-576-107-11	FUSE (3.15A/250V) (D390:US, CND/D590:US, CND)	
△F902	1-532-259-00	FUSE, TIME LAG (T1.6AL) (D390:UK, E/D590:UK)	
△F902	1-576-109-11	FUSE (5A/125V) (D390:US, CND/D590:US, CND)	
△F903	1-532-286-00	FUSE, TIME LAG (T2.5AL) (D390:UK, E/D590:UK)	
△F904	1-532-259-00	FUSE, TIME LAG (T1.6AL) (D390:E)	
△F951	1-532-237-00	FUSE, TIME LAG (T3.15AL) (D590)	
△F952	1-532-237-00	FUSE, TIME LAG (T3.15AL) (D590)	
△T901	1-450-365-21	TRANSFORMER, POWER (D390:US)	
△T901	1-450-620-21	TRANSFORMER, POWER (D390:CND)	
△T901	1-450-833-11	TRANSFORMER, POWER (D590:US, CND)	
△T901	1-450-834-11	TRANSFORMER, POWER (D590:UK)	
△T901	1-450-835-11	TRANSFORMER, POWER (D390:E)	
△T901	1-450-934-11	TRANSFORMER, POWER (D390:UK)	

ACCESSORIES & PACKING MATERIALS *****			
	1-465-423-11	REMOTE COMMANDER (RM-S103) (D390:US, UK, E)	
	1-501-374-11	ANTENNA, LOOP	
	1-501-536-11	ANTENNA (D390:UK/D590:UK)	
	1-693-100-11	COMMANDER, STANDARD (RM-U222) (D590)	
	1-693-101-11	COMMANDER, STANDARD (RM-U223) (D390:CND)	
	2-181-754-01	COVER, BATTERY (RM-S103) (D390:US, UK, E)	
	3-707-584-31	COVER, BATTERY (RM-U222/U223) (D390:CND/D590)	
	3-755-122-21	MANUAL, INSTRUCTION (ENGLISH) (D590)	

The components identified by mark △ or dotted line with mark △ are critical for safety. Replace only with part number specified.

Les composants identifiés par une marque △ sont critiques pour la sécurité. Ne les remplacer que par une pièce portant le numéro spécifié.

Ref. No.	Part No.	Description	Remark
	3-755-122-31	MANUAL, INSTRUCTION (FRENCH)	(D590:CND)
	3-755-123-11	MANUAL, INSTRUCTION (ENGLISH, FRENCH, SPANISH, CHINESE)	(D390:E)
	3-755-123-21	MANUAL, INSTRUCTION (ENGLISH)	(D390:US, CND, UK)
	3-755-123-31	MANUAL, INSTRUCTION (FRENCH)	(D390:CND)
	3-755-506-11	MANUAL, INSTRUCTION (ENGLISH, FRENCH)	(D390:CND)
*	4-952-676-01	CUSHION	
*	4-952-677-01	INDIVIDUAL CARTON	(D590:US, CND)
*	4-952-678-01	INDIVIDUAL CARTON	(D590:UK)
*	4-952-679-01	INDIVIDUAL CARTON	(D390:US, CND)
*	4-952-680-01	INDIVIDUAL CARTON	(D390:UK)
*	4-952-681-01	INDIVIDUAL CARTON	(D390:E)

HARDWARE LIST

- #1 7-682-548-09 SCREW +BVTT 3X8 (S)
- #2 7-682-560-04 SCREW +BVTT 4X6 (S)
- #3 7-685-647-79 SCREW +BVTP 3X10 TYPE2 IT-3
- #4 7-682-548-04 SCREW +BVTT 3X8 (S)
- #5 7-682-547-09 SCREW +BVTT 3X6 (S)
- #6 7-685-646-79 SCREW +BTP 3X8 TYPE2 N-S
- #7 7-621-849-00 SCREW, TAPPING